



천조코퍼레이션
CHUNJO CORPORATION

LR 11350

Technische Daten • Technical Data
Caractéristiques techniques • Dati tecnici
Datos técnicos • Технические данные



CHUNJO Corporation

9F Jung Woo B/D, 1111, Chunnhodaero, Gangdong-gu,
Seoul, Republic of Korea 05544

Tel : 82-2-489-3438

Fax : 82-2-489-3439

www.chunjo.com

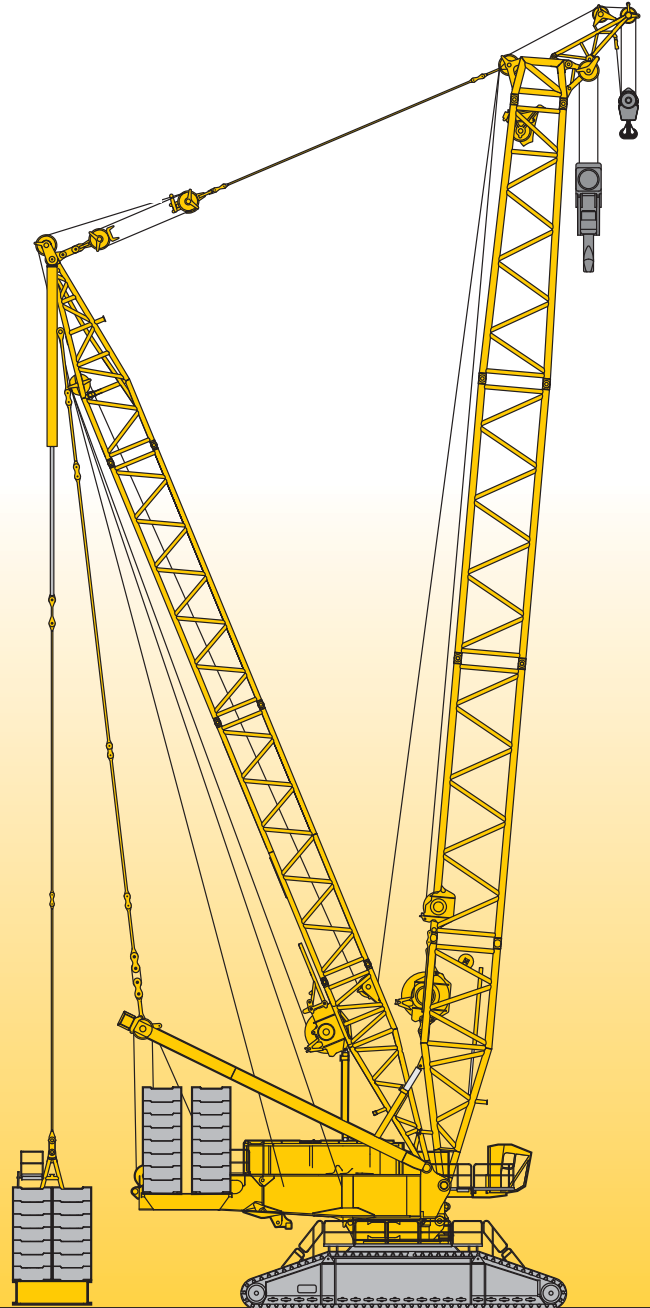

LIEBHERR

Inhaltsverzeichnis
Table of content
Tables des matières · Indice
Contenido · Оглавление

Inhaltsverzeichnis

Maße	4 – 8
Krandaten, Geschwindigkeiten	9
Transportplan	10 – 12
Auslegersysteme	13 – 14
Traglasten am SDBW2-Auslegersystem	15
Traglasten am SDB-Auslegersystem	16 – 17
Traglasten am SDB2-Auslegersystem	18 – 19
Traglasten am SDWB-Auslegersystem	20 – 25
Traglasten am SDWB2-Auslegersystem	26 – 31
Traglasten am SDWVB-Auslegersystem	32 – 33
Traglasten am SDWVB2-Auslegersystem	34 – 35

Table of content

Dimensions	4 – 8
Crane data, Hooks blocks and hooks	9
Transportation plan	10 – 12
Boom/jib combinations	13 – 14
Lifting capacities on SDBW2 boom	15
Lifting capacities on SDB boom	16 – 17
Lifting capacities on SDB2 boom	18 – 19
Lifting capacities on SDWB boom	20 – 25
Lifting capacities on SDWB2 boom	26 – 31
Lifting capacities on SDWVB boom	32 – 33
Lifting capacities on SDWVB2 boom	34 – 35

Tables des matières

Encombrement	4 – 8
Crane data, Organes de préhension	9
Plan de transport	10 – 12
Configurations de flèche	13 – 14
Forces de levage en configuration SDBW2	15
Forces de levage en configuration SDB	16 – 17
Forces de levage en configuration SDB2	18 – 19
Forces de levage en configuration SDWB	20 – 25
Forces de levage en configuration SDWB2	26 – 31
Forces de levage en configuration SDWVB	32 – 33
Forces de levage en configuration SDWVB2	34 – 35

Indice

Dimensioni	4 – 8
Dati gru, Mezzo di accoglienza carico	9
Piano di trasporto	10 – 12
Sistemi braccio	13 – 14
Portate su braccio SDBW2	15
Portate su braccio SDB	16 – 17
Portate su braccio SDB2	18 – 19
Portate su braccio SDWB	20 – 25
Portate su braccio SDWB2	26 – 31
Portate su braccio SDWVB	32 – 33
Portate su braccio SDWVB2	34 – 35

Contenido

Dimensiones	4 – 8
Características, Pastecas	9
Esquema de transporte	10 – 12
Sistemas de pluma	13 – 14
Tablas de carga con pluma SDBW2	15
Tablas de carga con pluma SDB	16 – 17
Tablas de carga con pluma SDB2	18 – 19
Tablas de carga con pluma SDWB	20 – 25
Tablas de carga con pluma SDWB2	26 – 31
Tablas de carga con pluma SDWVB	32 – 33
Tablas de carga con pluma SDWVB2	34 – 35

Оглавление

Размеры	4 – 8
Технические характеристики крана, Грузозахватные органы	9
Транспортная схема	10 – 12
Стреловые системы	13 – 14
Грузоподъемность на SDBW2-стреле	15
Грузоподъемность на SDB-стреле	16 – 17
Грузоподъемность на SDB2-стреле	18 – 19
Грузоподъемность на SDWB-стреле	20 – 25
Грузоподъемность на SDWB2-стреле	26 – 31
Грузоподъемность на SDWVB-стреле	32 – 33
Грузоподъемность на SDWVB2-стреле	34 – 35

Maße
Dimensions
Encombrement · Dimensioni
Dimensiones · Размеры

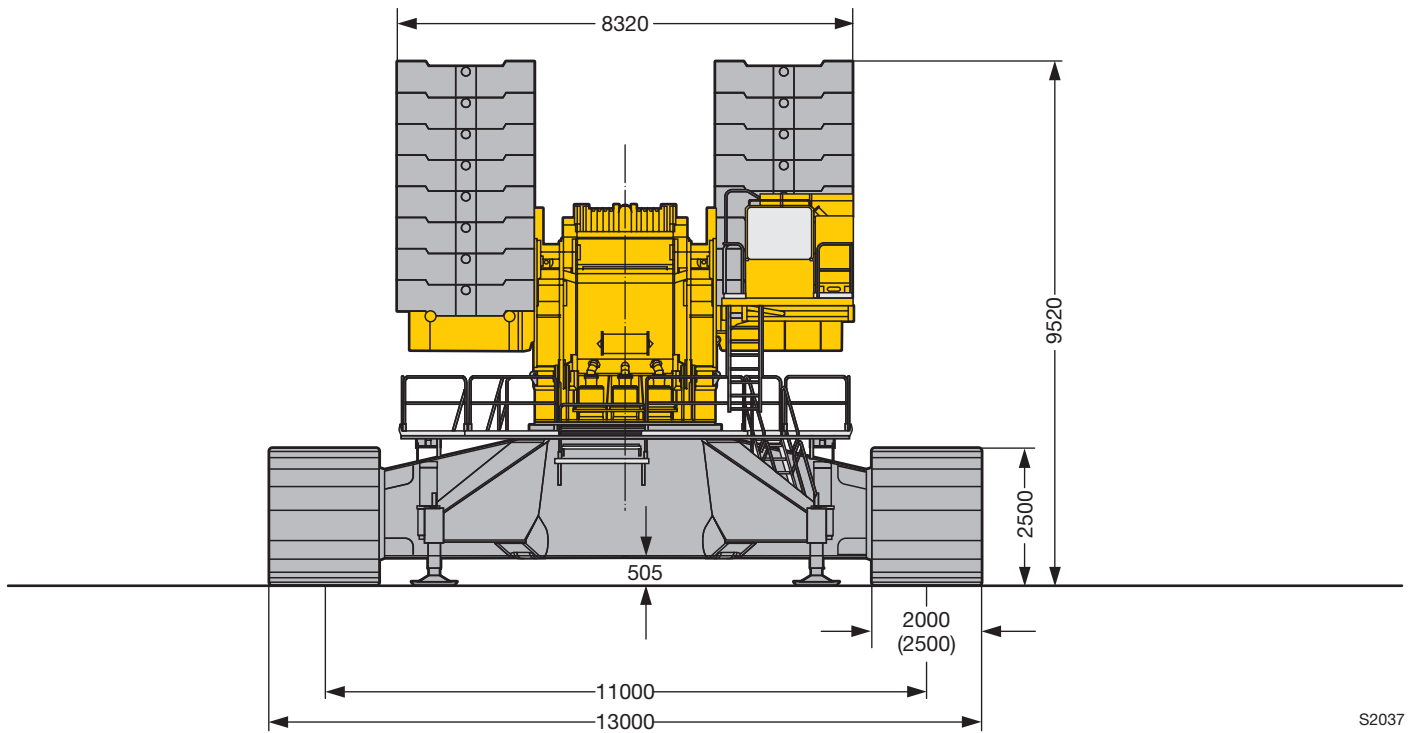
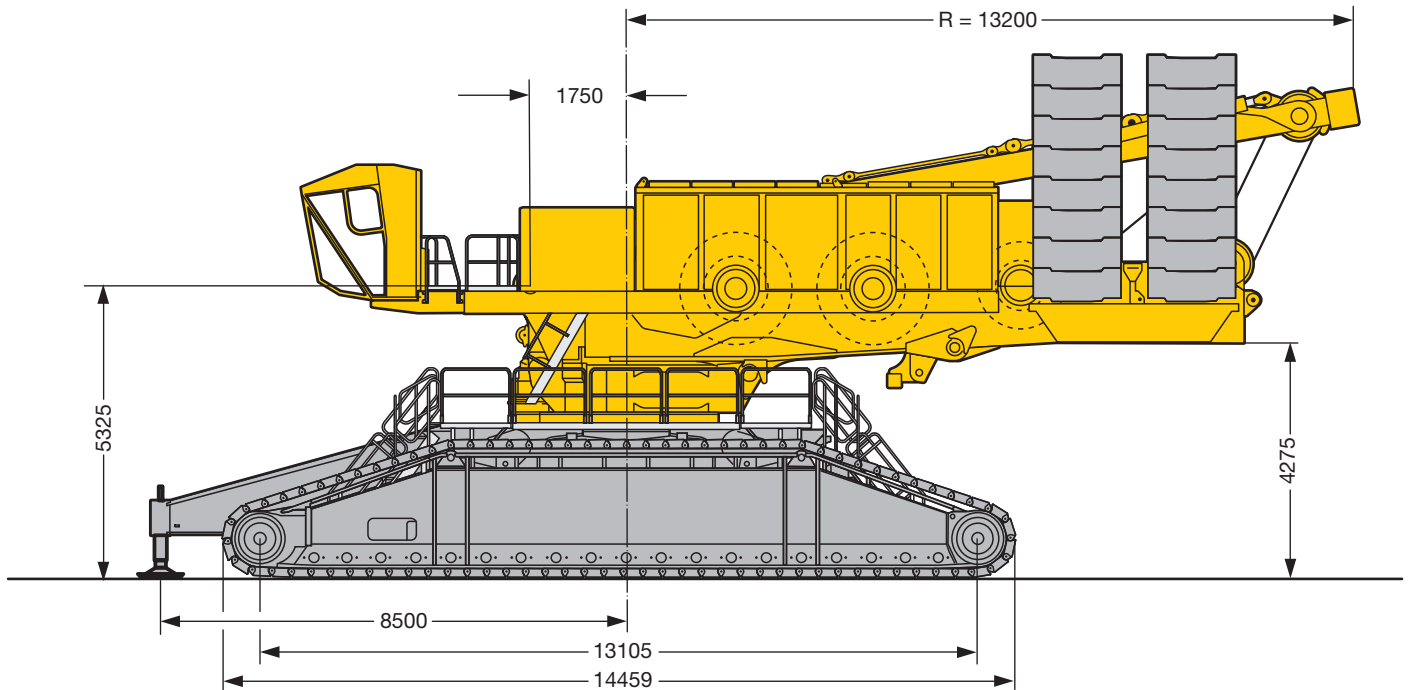

S2037

Maße
Dimensions
Encombremet · Dimensioni
Dimensiones · Размеры

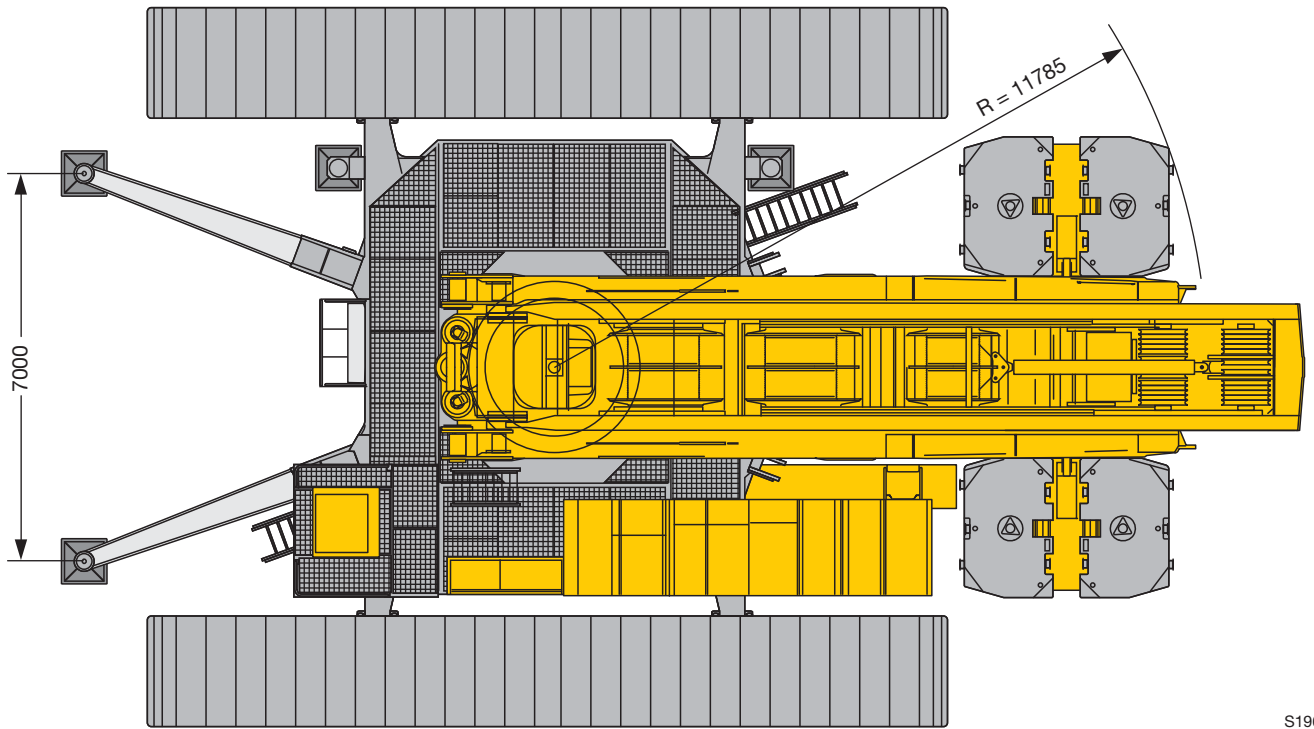

S1960

Maße
Dimensions
Encombremet · Dimensioni
Dimensiones · Размеры

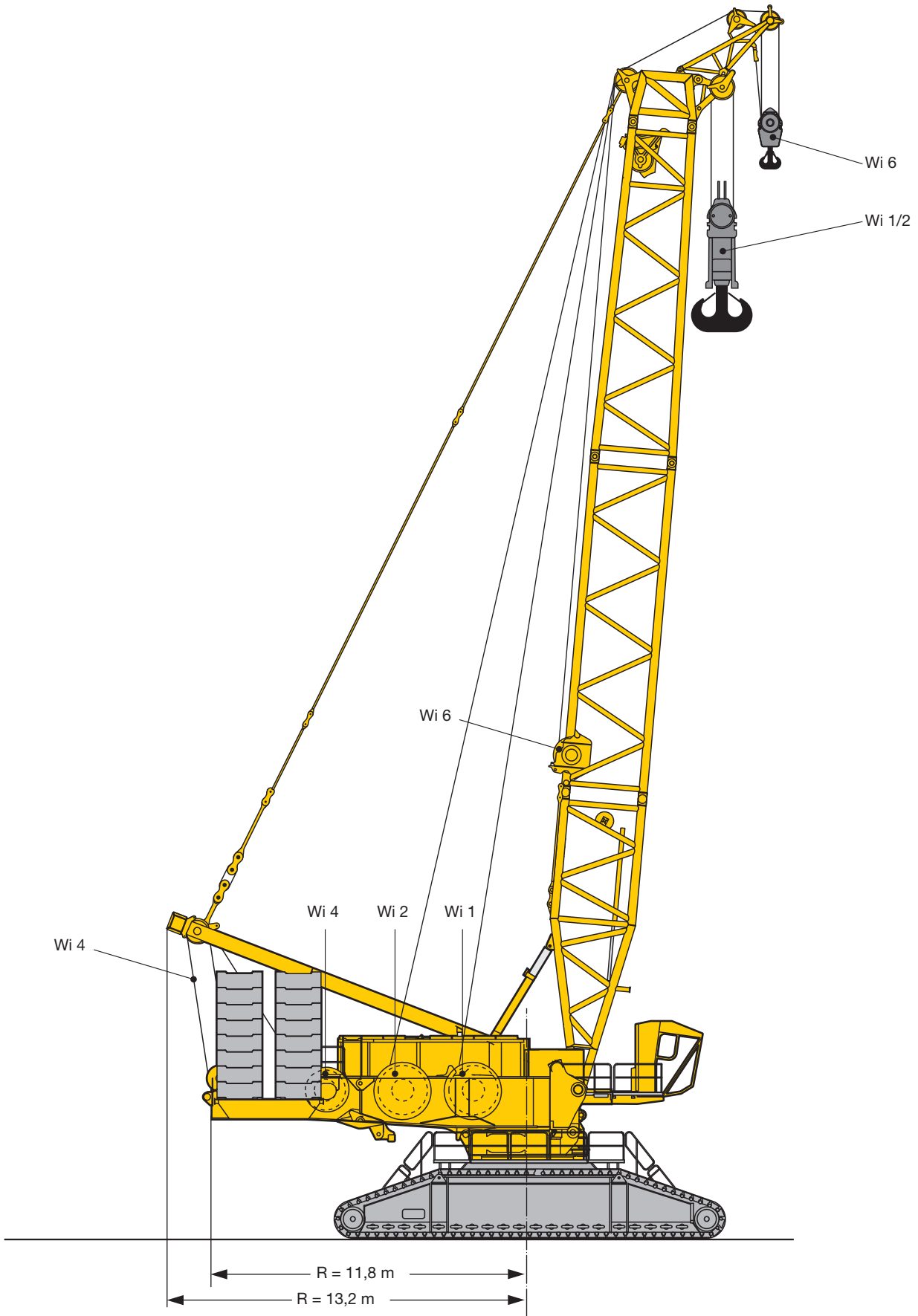

S 2045

Maße
Dimensions
Encombremet · Dimensioni
Dimensiones · Размеры

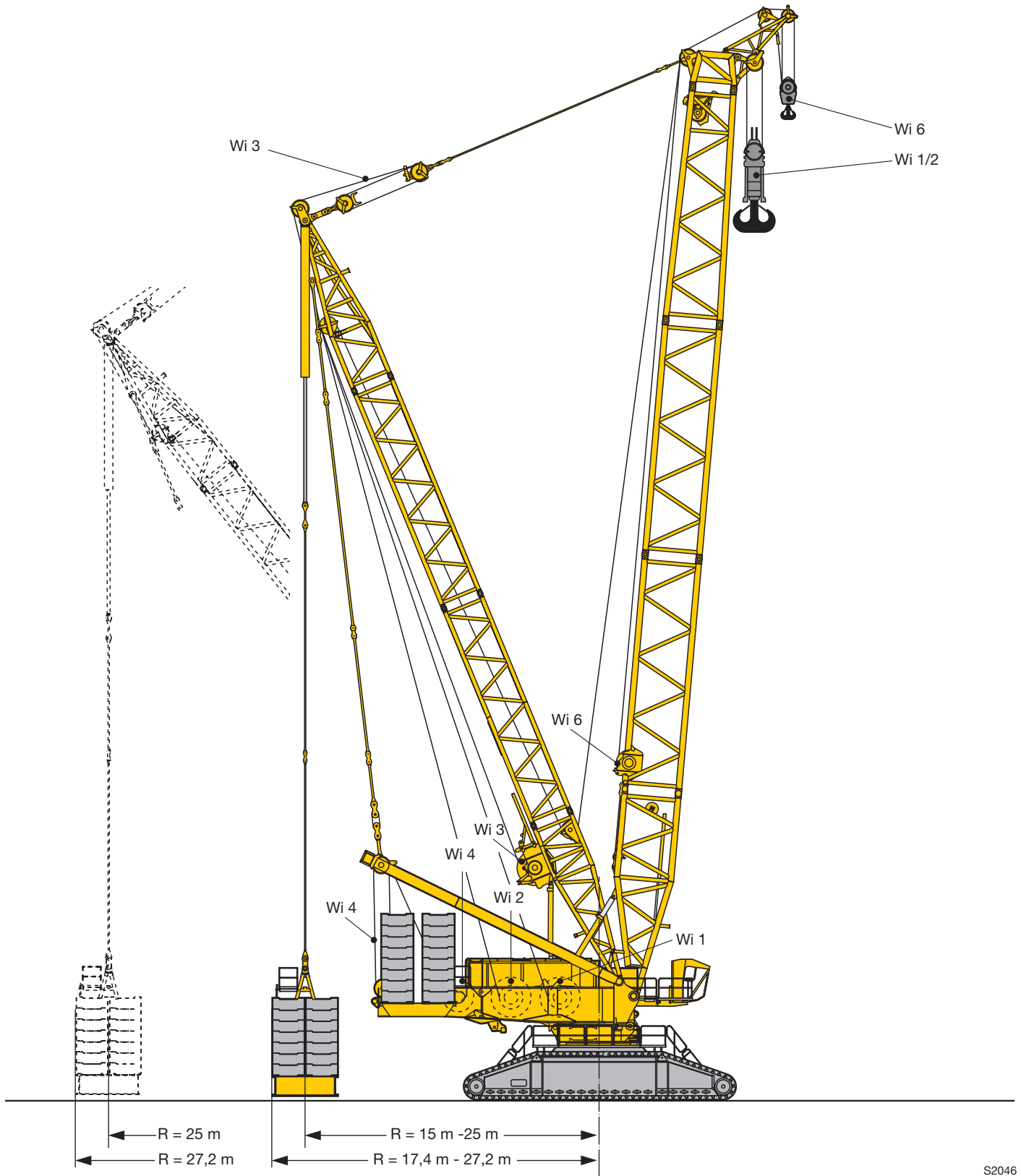

S2046

Maße
Dimensions
Encombremet · Dimensioni
Dimensiones · Размеры

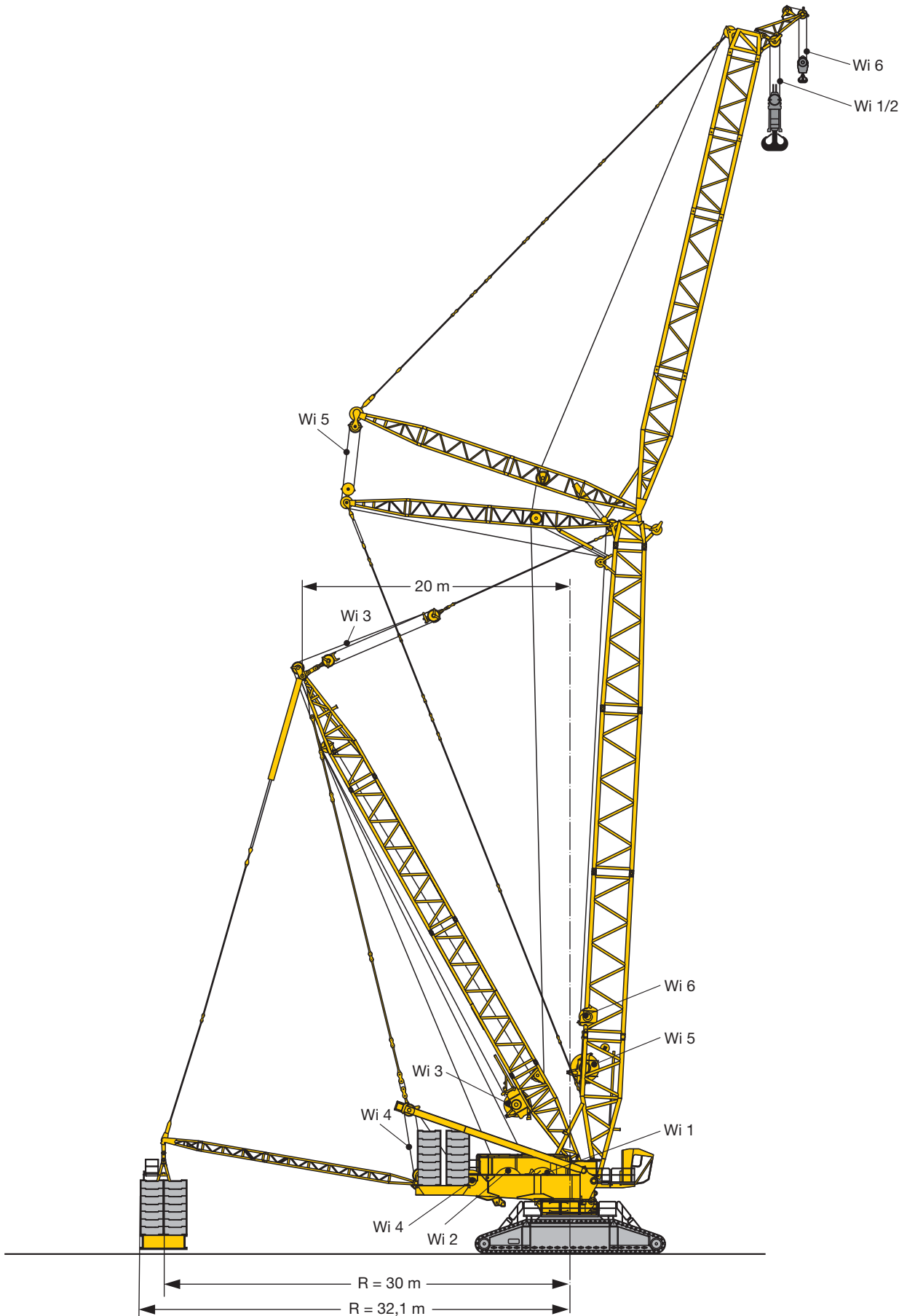







S2047

Krandaten

Crane data

Datos de la grue · Dati gru

Características · Технические характеристики крана



Antriebe · Drive Mécanismes · Meccanismi Accionamiento · Приводы	Geschwindigkeiten · Working speeds Witesses · Velocità Velocidades · Скорости	Max. Seilzug · Max. single line pull Effort au brin maxi · Mass. tiro diretto fune Tiro máx. en cable · Макс. тяговое усилие	Seil Ø / Seillänge · Rope diameter / length Diamètre / Longueur du câble · Diametro / lunghezza fune Diámetro / longitud cable · Диаметр / длина троса
	0 – 136	310 kN	38 mm / 1500 m
	0 – 136	310 kN	38 mm / 1500 m
	0 – 150		
	0 – 2 x 81		
	0 – 136		
	0 – 156	160 kN	28 mm / 1000 m

Geschwindigkeiten

Working speeds

Vitesses · Velocità

Velocidades · Скорости

	Drehgeschwindigkeiten · Slewing speeds Vitesses d'orientation · Velocità di rotazione Velocidades de giro · Скорости вращения	0 - 82 min ⁻¹ /об/мин
	Fahrgeschwindigkeiten · Travel speeds Vitesses de translation · Velocità di trasferimento Velocidades de traslación · Скорости хода	0 - 1,08
	Max. Lastmoment · Max. rating Couple de charge maxi · Max. momento di carico Momento de carga máx. · Макс. грузовой момент	22748 tm

Transportplan
Transportation plan
Plan de transport · Piano di trasporto
Esquema de transporte · Транспортная схема

Raupenmittelteil mit Dreheinrichtung (3 Drehwerke)
 Crawler middle section with rotating (3 slewing gears)
 Partie centrale des chenilles avec système de rotation
 (3 mécanismes d'orientation)

Sezione cingolo centrale con motore di rotazione (3 ralle)
 Chasis de las cadenas con sistema giratorio (3 reductores de giro)
 Гусеничная тележка с поворотным устройством
 (3 механизма поворота)

43 t

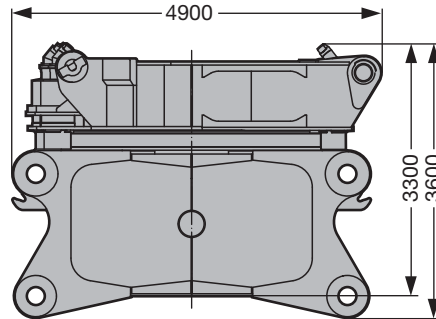

Breite / width / largeur / larghezza / anchura / ширина 3,5 m

Querträger
 Cross-beam
 Traverse

Traversa
 Viga central
 Поперечная часть

2 x 45 t

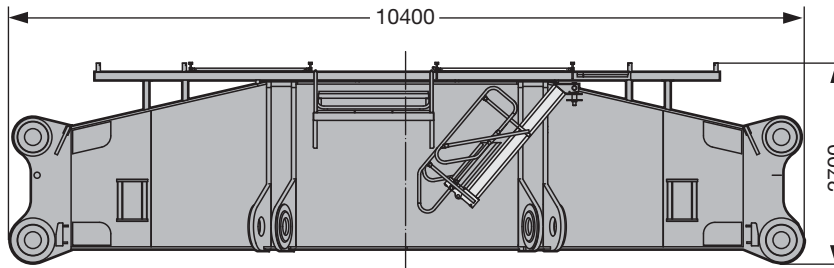

Breite / width / largeur / larghezza / anchura / ширина 2,55 m

Raupenträger mit 2 Fahrantrieben
 Crawler incl. 2 driving gears
 Longeron avec 2 mécanismes de translation

Cingoli con 2 motori di trazione
 Cadenas – incluidos 2 motores de traslación –
 Гусеничный движитель с 2-мя ходовыми приводами

2 x

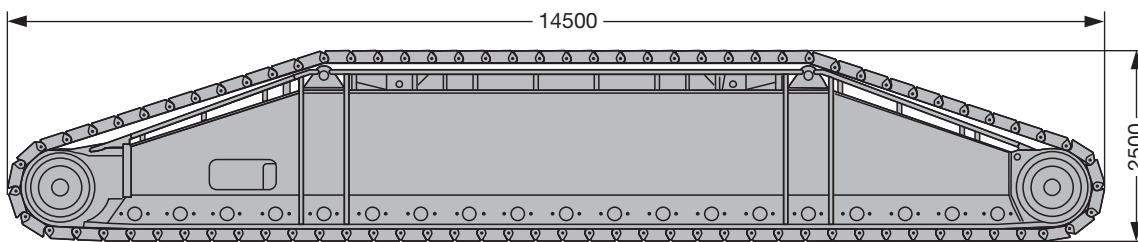

Breite / width / largeur / larghezza / anchura / ширина 2 m/2,5 m

	2,0 m	2,5 m
mit Bodenplatten / with crawler shoes / avec tuiles / con piastre cingoli / con planchas para apoyos / с траками	70,5 t	83,5 t
ohne Bodenplatten / without crawler shoes / sans tuiles / senza piastre cingoli / sin planchas para apoyos / без траков	38,5 t	38,5 t
Bodenplatten / crawler shoes / tuiles / piastre cingoli / planchas / Траки	31,5 t	45,0 t

S2038

Transportplan
Transportation plan
Plan de transport · Piano di trasporto
Esquema de transporte · Транспортная схема

Drehbühne Vorderteil (ohne Hubwinde)
 Slewing platform, front part (without hoist winch)
 Avant de la partie tournante (sans treuil de levage)

Piattaforma girevole, parte frontale (senza argano)
 Parte frontal de superestructura – sin cabrestante de elevación –
 Передняя часть поворотной платформы (без грузовой лебедки)

30,8 t

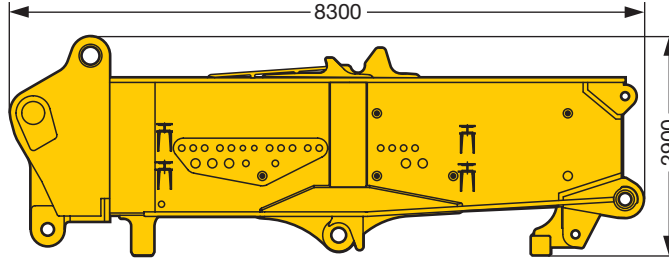

Breite / width / largeur / larghezza / anchura / ширина 3,4 m

Drehbühne Heckteil mit SA-Bock und Winde 4
 Slewing platform, rear part with SA-frame incl. winch 4
 Arrière de la partie tournante avec chevalet SA et treuil 4

Piattaforma girevole, parte posteriore con cavalletto SA e argano 4
 Parte trasera de superestructura con SA-Bock incl. cabrestante 4
 Задняя часть поворотной платформы с SA-стойкой и лебедкой 4

44 t

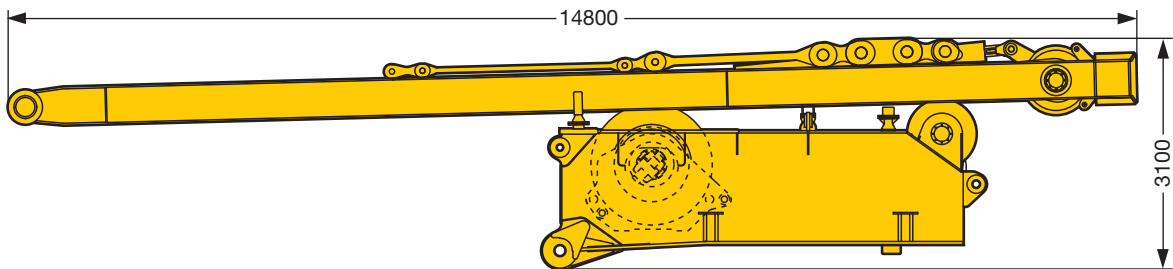

Breite / width / largeur / larghezza / anchura / ширина 3,3 m

Maschinenhaus mit Laufsteg und Kabine
 Machine-room with walk and cabin
 Bâti de la machine avec passerelle et cabine

Corpo macchina con passerella e cabina
 Caja – motor con pasarelas y cabina
 Машинное отделение с мостками и кабиной

17,6 t

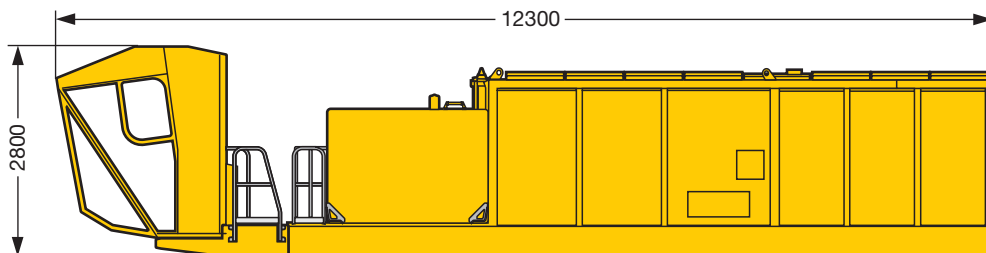

Breite / width / largeur / larghezza / anchura / ширина 2,5 m

S2039

Transportplan
Transportation plan
Plan de transport · Piano di trasporto
Esquema de transporte · Транспортная схема

Winde 1
 Winch 1
 Treuil 1

Argano 1
 Cabrestante 1
 Лебедка 1

Winde 2
 Winch 2
 Treuil 2

Argano 2
 Cabrestante 2
 Лебедка 2

22,8 t

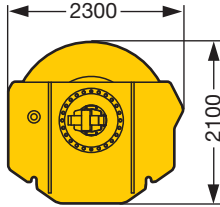

Breite / width / largeur / larghezza / anchura / ширина 2,3 m

22,8 t

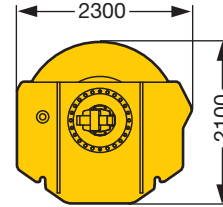

Breite / width / largeur / larghezza / anchura / ширина 2,3 m

Ballastkonsole Drehbühne
 Counterweight bracket superstructure
 Support du contrepoids de la partie tournante
 Supporto zavorra piattaforma girevole
 Soporte de contrapeso de superestructura
 Консоль противовеса поворотной платформы

2 x 10,2 t

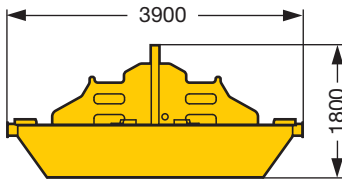

Breite / width / largeur / larghezza / anchura / ширина 2,5 m

Drehbühnenballast
 Counterweight slabs
 Contrepoids de la partie tournante
 Zavorra piattaforma girevole
 Placas de contrapeso
 Противовес поворотной платформы

32 x 10 t

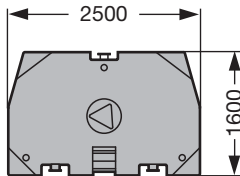

Dicke / thick / epaisseur / spessore / grosor / Толщина 0,6 m

Zentralballast
 Center counterweight
 Contrepoids de base
 Zavorra centrale
 Contrapeso central
 Центральный противовес

4 x 7,5 t

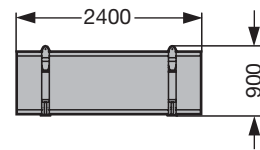

Breite / width / largeur / larghezza / anchura / ширина 1,2 m

S2040

Auslegersysteme
Boom/jib combinations
Configurations de flèche · Sistemi braccio
Sistemas de pluma · Стреловые системы

S Hauptausleger, schwer
 Main boom, heavy
 Flèche principale, lourde
 Braccio principale, per carichi pesanti
 Pluma principal, pesada
 Основная стрела, тяжелая

D Derrickausleger
 Derrick
 Flèche derrick
 Braccio Derrick
 Pluma Derrick
 Деррик-стрела

B Schwebeballast
 Suspended ballast
 Lest suspendu
 Zavorra sospesa
 Contrapeso flotante
 Подвесной противовес

SL Hauptausleger, schwer/leicht
 Main boom, heavy/light
 Flèche principale, lourde/légère
 Braccio principale, per carichi pesanti/leggeri
 Pluma principal, pesada / ligera
 Основная стрела, тяжелая/легкая

W Wippbare Gitterspitze, schwer
 Luffing fly jib, heavy
 Flèche, lourde
 Falcone tralicciato a volata variabile, per carichi pesanti
 Pluma abatible, pesada
 Качающийся решетчатый удлинитель, тяжелый

BW Ballastwagen
 Ballast trailer
 Porteur de lest
 Carrello contrappeso
 Carro de contrapeso
 Тележка противовеса



SL

SL 42 m – 102 m

**SLD
 SLDB/BW**

SL 48 m – 144 m
 D 42 m

S

S 30 m – 90 m

**SD
 SDB/BW**

S 48 m – 150 m

S1968

Auslegersysteme
Boom/jib combinations
 Configurations de flèche · Sistemi braccio
 Sistemas de pluma · Стреловые системы

- S - 3227
- LI - 2621
- D - 2620

- S/W 1350 t Kopf/Head/Tete/
Testa/Cabezal/Оголовок
- W 200 t Kopf/Head/Tete
Testa/Cabezal/Оголовок

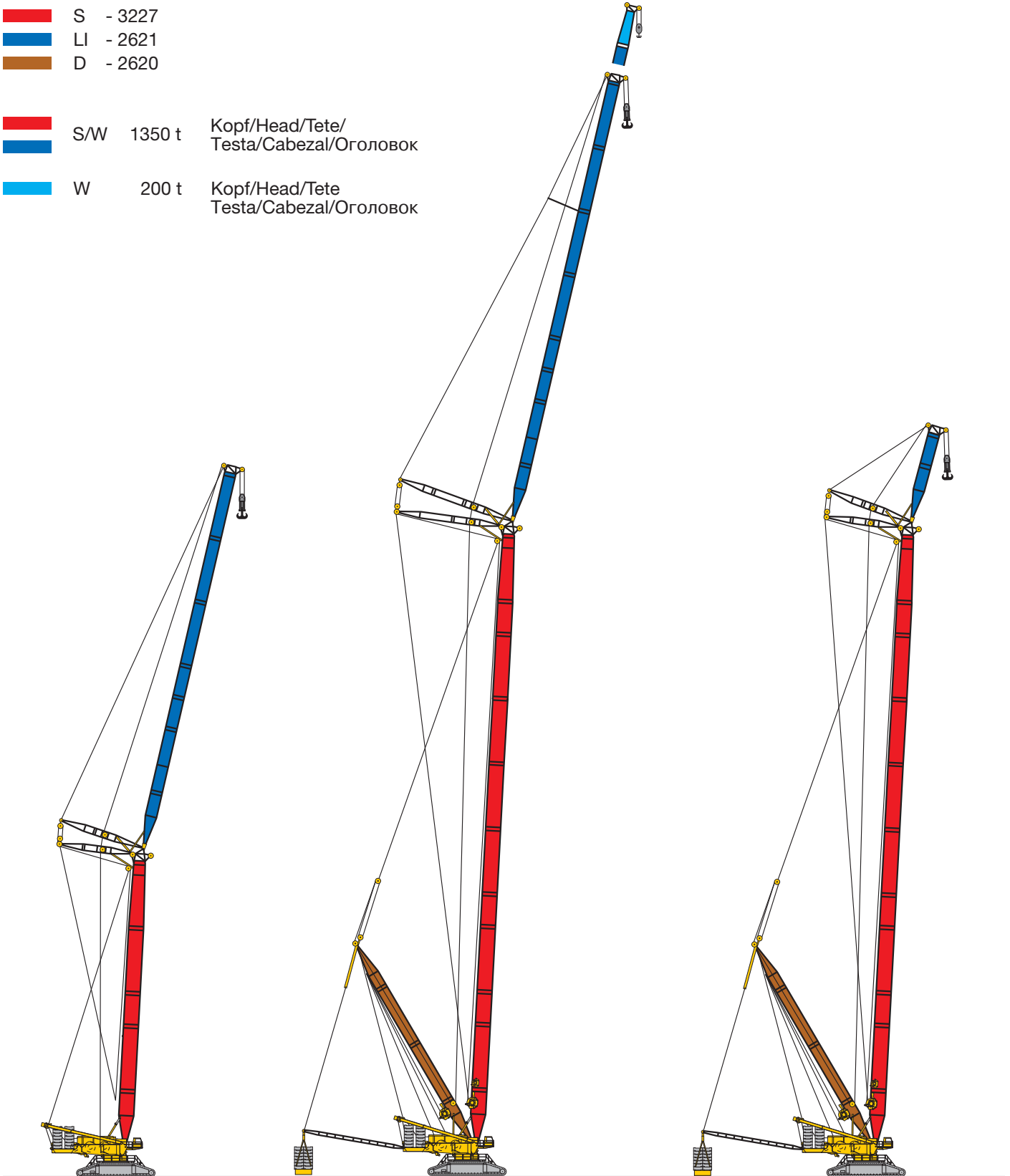

SW

auf Anfrage

**SDW
SDWB/BW**

S 48 m – 114 m
 W 36 m – 84 m/114 m
 D 42 m

**SDWV
SDWVB/BW**

S 48 m – 114 m
 WV 12 m – 18 m
 D 42 m

S1968

Traglasten am SDBW2-Auslegersystem

Lifting capacities on SDBW2 boom/derrick combination

Forces de levage en configuration SDBW2 · Portate con sistema braccio SDBW2

Tablas de carga con sistema de pluma SDBW2 · Грузоподъемность на стреловой системе SDBW2

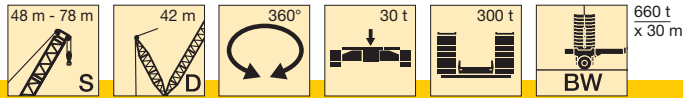

Vorläufig
 Préliminaire · Provisorio
 Provisional · Временно
 Preliminary

	48 m	54 m	60 m	66 m	72 m	78 m	
10	1309						10
11	1291	1335					11
12	1275	1319	1350	1252			12
14	1249	1292	1312	1248	1116	981	14
16	1228	1270	1262	1216	1107	972	16
18	1211	1223	1192	1158	1094	963	18
20	1133	1120	1111	1082	1036	945	20
22	1034	1016	1014	1001	977	916	22
24	935	930	917	917	907	886	24
26	853	850	843	833	835	824	26
28	787	775	777	769	763	763	28
30	722	722	711	714	706	701	30
32	675	670	664	658	659	651	32
34	631	621	621	613	612	611	34
36	586	586	578	577	568	571	36
38	540	550	543	541	538	530	38
40	494	515	514	505	508	502	40
44	408	459	457	456	449	449	44
48		393	415	408	408	402	48
52			372	373	367	367	52
56				341	338	332	56
60				304	309	307	60
64					286	282	64
68						262	68

TAB 190074

Traglasten am SDB-Auslegersystem

Lifting capacities on SDB boom/derrick combination

Forces de levage en configuration SDB · Portate con sistema braccio SDB

Tablas de carga con sistema de pluma SDB · Грузоподъемность на стреловой системе SDB

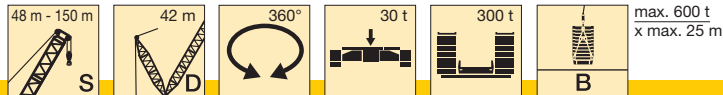

Vorläufig
Préliminaire · Provisorio
Provisional · Временно
Preliminary

	48 m	54 m	60 m	66 m	72 m	78 m	84 m	90 m	96 m	102 m	108 m	114 m	120 m	126 m	132 m	138 m	144 m	150 m		
10	1250																			10
11	1250	1250																		11
12	1250	1250	1235	1146																12
14	1192	1215	1168	1098	1016	933														14
16	1162	1137	1101	1046	978	906	830	745	666											16
18	1072	1059	1026	987	938	877	811	733	660	591	530	473								18
20	969	968	950	922	887	843	788	722	651	582	528	473	417	385						20
22	888	877	873	857	835	802	759	710	642	576	521	468	417	382	339	302	275			22
24	812	807	796	792	780	760	728	687	632	570	517	463	415	377	337	302	274	243		24
26	746	744	735	726	724	712	694	665	619	551	507	459	413	373	333	299	271	243		26
28	689	683	681	673	668	663	651	636	607	552	500	451	410	372	331	298	269	243		28
30	633	637	628	626	621	615	609	599	582	544	494	446	397	363	329	296	267	242		30
32	586	591	587	579	579	573	567	563	550	522	487	442	396	359	320	293	266	241		32
34	541	548	548	540	538	537	530	526	518	498	469	434	392	356	320	289	262	238		34
36	497	514	510	508	500	501	499	494	487	474	451	422	384	354	318	287	261	234		36
38	465	481	479	476	472	465	468	466	458	450	434	409	374	343	315	285	259	232		38
40	434	447	453	444	445	440	436	439	434	427	416	396	364	333	305	282	258	230		40
44	374	393	401	400	393	393	390	385	385	384	379	369	344	322	293	270	246	224		44
48		347	357	357	356	351	350	350	344	341	340	337	321	307	281	261	237	215		48
52			319	326	320	320	315	314	312	309	302	304	296	285	267	251	230	209		52
56				292	294	288	288	286	281	281	278	275	271	264	251	238	221	204		56
60				262	269	266	261	262	258	253	253	253	249	243	234	225	210	194		60
64					241	244	242	238	237	234	229	230	229	225	218	211	200	184		64
68						222	222	221	216	216	212	210	208	207	202	197	189	174		68
72							206	204	201	198	196	195	191	188	186	184	177	164		72
76								190	187	184	179	180	177	173	170	170	164	155		76
80								173	173	171	167	165	164	161	158	156	152	145		80
84									160	159	156	154	150	149	146	145	139	136		84
88										148	144	144	140	137	135	135	130	127		88
92											135	133	129	128	124	125	120	118		92
96											127	120	119	119	116	114	111	109		96
100												111	111	110	108	106	101	100		100
104													104	103	100	99	94	91		104
108														96	93	92	87	84		108
112															90	86	85	80	78	112
116																80	79	74	72	116
120																	73	68	65	120
124																		63	60	124
128																			55	128
132																			50	132

TAB 190066

Traglasten am SDB-Auslegersystem

Lifting capacities on SDB boom/derrick combination

Forces de levage en configuration SDB · Portate con sistema braccio SDB

Tablas de carga con sistema de pluma SDB · Грузоподъемность на стреловой системе SDB



max. 600 t
x max. 25 m

Vorläufig
Préliminaire · Provisorio
Provisional · Временно
Preliminary

	48 m	54 m	60 m	66 m	72 m	78 m	84 m	90 m	96 m	102 m	108 m	114 m	120 m	126 m	132 m	138 m	144 m	150 m		
10	1250																			10
11	1250	1250																		11
12	1250	1239	1187	1112																12
14	1195	1154	1118	1058	982	907														14
16	1107	1078	1049	1002	939	876	810	739	666											16
18	1022	1003	987	947	895	842	785	729	660	590	530	473								18
20	937	924	920	893	852	807	759	710	648	580	526	473	417	383						20
22	860	845	845	832	809	772	731	690	641	576	516	467	417	380	339	302	274			22
24	785	780	769	767	756	736	703	668	627	570	515	463	414	374	334	301	272	243		24
26	723	718	711	702	700	689	671	646	610	559	505	459	411	372	331	299	271	243		26
28	671	661	660	652	645	642	631	617	592	552	500	450	406	369	329	298	268	242		28
30	619	619	609	608	601	595	590	582	565	544	494	446	400	361	327	295	267	240		30
32	578	576	571	565	564	556	550	547	535	519	487	442	396	358	322	292	264	239		32
34	537	537	537	528	527	524	516	512	504	493	467	434	392	354	319	290	261	236		34
36	497	507	502	499	491	491	488	481	474	467	448	421	384	352	316	287	259	234		36
38	465	477	473	470	466	459	460	457	447	441	428	407	374	345	313	285	258	232		38
40	434	447	448	440	441	435	431	432	425	418	409	394	364	337	304	282	256	230		40
44	374	393	400	398	392	391	388	383	382	379	372	367	344	322	293	270	246	223		44
48		347	356	356	356	351	349	349	343	340	337	335	321	307	281	261	237	215		48
52			319	326	320	320	315	314	312	309	302	303	296	285	267	251	230	209		52
56				292	294	288	288	286	281	281	278	275	271	264	251	238	221	204		56
60				262	269	266	261	262	258	253	253	249	243	234	225	210	194			60
64					241	244	242	238	237	234	229	231	229	225	218	211	200	184		64
68						222	222	221	216	216	212	210	208	207	202	197	189	174		68
72							206	204	201	198	196	195	191	188	186	184	177	164		72
76								190	187	184	179	180	177	173	170	170	164	155		76
80								173	173	171	167	165	164	161	158	156	152	145		80
84									160	159	156	154	150	149	146	145	139	136		84
88										148	144	144	140	137	135	135	130	127		88
92											135	133	129	128	124	125	120	118		92
96											127	120	119	119	116	114	111	109		96
100												111	111	110	108	106	101	100		100
104													104	103	100	99	94	91		104
108														96	93	92	87	84		108
112														90	86	85	80	78		112
116															80	79	74	72		116
120																73	68	65		120
124																	63	60		124
128																		55		128
132																		50		132

TAB 190067

Traglasten am SDB2-Auslegersystem

Lifting capacities on SDB2 boom/derrick combination

Forces de levage en configuration SDB2 · Portate con sistema braccio SDB2

Tablas de carga con sistema de pluma SDB2 · Грузоподъемность на стреловой системе SDB2

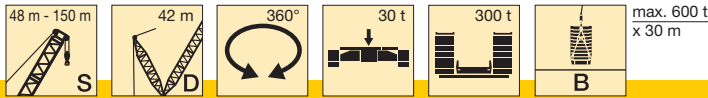

Vorläufig
Préliminaire · Provisorio
Provisional · Временно
Preliminary

	48 m	54 m	60 m	66 m	72 m	78 m	84 m	90 m	96 m	102 m	108 m	114 m	120 m	126 m	132 m	138 m	144 m	150 m			
10	1250																			10	
11	1250	1250																		11	
12	1250	1250	1250	1190																12	
14	1237	1250	1250	1151	1059	967														14	
16	1216	1217	1172	1106	1027	947	859	762	680											16	
18	1169	1145	1114	1061	993	923	846	753	676	602	538	473								18	
20	1078	1060	1048	1014	956	898	831	748	669	597	536	473	417	383						20	
22	993	976	969	953	919	869	811	741	665	593	533	473	417	382	341	302	275			22	
24	910	903	890	884	865	839	789	730	653	589	529	473	417	380	339	302	274	243		24	
26	840	834	827	814	807	790	762	720	654	583	526	472	417	379	338	302	273	243		26	
28	781	769	768	758	749	740	721	697	647	577	522	465	417	377	336	302	271	243		28	
30	722	719	710	707	699	691	680	663	627	572	519	464	415	375	335	301	270	243		30	
32	676	669	665	657	655	647	639	628	601	556	513	460	412	373	330	299	269	242		32	
34	632	623	622	614	611	608	601	594	575	540	502	453	409	371	330	298	267	241		34	
36	587	587	580	578	570	570	567	561	549	524	492	450	401	368	328	296	266	238		36	
38	541	551	545	542	539	531	533	531	522	508	481	444	400	363	326	295	264	236		38	
40	495	517	516	506	509	503	499	501	496	489	470	438	396	360	323	293	263	234		40	
44	409	459	458	457	450	450	447	442	442	441	435	423	388	353	318	288	256	229		44	
48		394	416	409	409	403	402	402	396	393	392	388	368	345	314	284	252	224		48	
52			373	374	368	368	363	362	361	357	350	352	341	325	303	279	246	219		52	
56				341	338	333	333	330	326	326	323	320	315	305	289	269	240	214		56	
60				306	310	307	302	303	300	295	295	295	291	285	276	259	233	207		60	
64					286	282	280	276	276	273	268	270	268	264	260	248	226	202		64	
68						262	259	257	253	253	249	247	245	243	241	234	220	196		68	
72							240	239	236	232	231	230	225	223	222	218	207	190		72	
76								222	219	217	212	213	210	206	203	203	194	181		76	
80								208	204	202	198	196	195	192	189	187	181	172		80	
84									191	188	185	184	180	178	176	175	169	164		84	
88										176	172	172	168	165	164	163	158	155		88	
92											162	160	158	154	151	152	147	145		92	
96											152	150	147	145	142	140	137	135		96	
100												141	138	135	133	131	126	125		100	
104													128	126	124	123	118	116		104	
108														117	115	115	111	108		108	
112															111	108	107	103	101		112
116																102	100	95	94		116
120																	94	89	86		120
124																		83	81		124
128																			75		128
132																				70	132

TAB 190068

Traglasten am SDB2-Auslegersystem

Lifting capacities on SDB2 boom/derrick combination

Forces de levage en configuration SDB2 · Portate con sistema braccio SDB2

Tablas de carga con sistema de pluma SDB2 · Грузоподъемность на стреловой системе SDB2

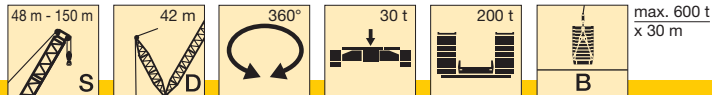

Vorläufig
Préliminaire · Provisorio
Provisional · Временно
Preliminary

	48 m	54 m	60 m	66 m	72 m	78 m	84 m	90 m	96 m	102 m	108 m	114 m	120 m	126 m	132 m	138 m	144 m	150 m		
10	1250																			10
11	1250	1250																		11
12	1250	1250	1242	1157																12
14	1250	1226	1179	1111	1025	942														14
16	1189	1153	1117	1062	988	918	842	762	680											16
18	1117	1082	1059	1013	952	889	823	754	675	602	538	473								18
20	1046	1014	996	965	912	859	802	743	670	597	536	473	417	383						20
22	966	946	929	909	873	827	778	730	665	593	533	473	417	382	340	302	275			22
24	883	878	862	848	824	795	753	711	656	589	529	473	417	380	339	302	273	243		24
26	815	810	802	788	774	752	725	692	645	583	526	471	417	379	337	302	272	243		26
28	757	746	745	735	724	710	689	667	633	578	522	467	417	377	335	302	271	243		28
30	699	699	688	687	679	667	653	636	611	572	519	464	414	375	334	301	270	243		30
32	658	652	647	639	638	629	618	606	585	553	513	460	411	373	332	299	269	242		32
34	617	609	608	598	596	593	584	575	559	534	499	455	408	371	330	297	267	241		34
36	576	576	569	566	558	557	553	545	533	514	486	448	400	368	328	296	266	238		36
38	535	543	537	533	530	522	522	518	507	495	472	441	400	361	326	294	264	236		38
40	494	511	509	500	501	495	491	491	483	475	458	434	396	360	322	291	263	234		40
44	409	458	456	454	447	447	443	437	435	432	424	416	388	353	318	288	254	229		44
48		394	415	409	408	402	401	399	393	389	387	383	368	345	314	284	252	224		48
52			373	374	368	367	363	361	359	356	349	349	341	325	303	279	246	219		52
56				341	338	333	333	330	326	325	322	319	314	305	290	269	240	214		56
60				306	310	307	302	303	300	295	295	294	290	285	276	259	233	207		60
64					286	282	280	276	276	273	268	270	267	264	260	248	226	202		64
68						262	259	257	253	253	249	247	244	243	241	234	220	196		68
72							240	239	236	232	231	230	225	223	222	218	207	190		72
76								222	219	217	212	213	210	206	203	194	181	176		76
80								208	204	202	198	196	195	192	189	187	181	172		80
84									191	188	185	184	180	178	176	175	169	164		84
88										176	172	172	168	165	164	163	158	155		88
92											162	160	158	154	151	152	147	145		92
96											152	150	147	145	142	140	137	135		96
100												141	138	135	133	131	126	125		100
104													128	126	124	123	118	116		104
108														117	115	115	111	108		108
112															111	108	107	103	101	112
116																102	100	95	94	116
120																	94	89	86	120
124																		83	81	124
128																			75	128
132																			70	132

TAB 190069

Traglasten am SDWB-Auslegersystem

Lifting capacities on SDWB boom/jib combination

Forces de levage en configuration SDWB · Portate con sistema braccio SDWB

Tablas de carga con sistema de pluma SDWB · Грузоподъемность на стреловой системе SDWB

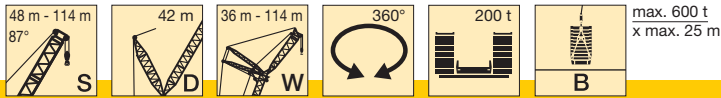

Vorläufig
Préliminaire · Provisorio
Provisional · Временно
Preliminary

m	48 m													m	
	36 m	42 m	48 m	54 m	60 m	66 m	72 m	78 m	84 m	90 m	96 m	102 m	108 m		114 m
16	622														16
18	612	538													18
20	599	528	468	412											20
22	579	517	461	407	359										22
24	558	504	452	402	354	311	273								24
26	524	491	443	394	350	307	272	238							26
28	488	467	433	385	344	304	270	237	209	193					28
30	449	438	422	379	339	301	266	235	207	192	153				30
32	413	409	398	373	333	296	263	233	205	190	150	141	124		32
34	379	380	375	358	329	292	260	230	203	188	147	139	123	109	34
36	344	352	352	340	321	288	255	228	201	186	144	137	121	108	36
38	308	327	329	322	307	284	250	225	198	185	141	135	120	106	38
40		301	307	303	294	275	245	223	196	183	139	133	119	104	40
44			268	267	264	258	232	219	191	179	133	129	116	101	44
48			227	237	235	235	218	213	184	176	128	125	114	98	48
52				207	210	211	201	208	176	169	123	122	112	95	52
56				171	185	190	183	190	168	161	119	119	109	92	56
60					153	170	168	172	161	153	114	115	107	89	60
64						145	155	157	153	144	111	112	104	86	64
68						107	134	142	141	135	107	109	102	83	68
72							112	126	129	127	104	107	99	80	72
76							72	109	115	119	101	105	97	77	76
80								88	102	111	99	102	94	74	80
84									86	103	96	100	92	71	84
88									56	94	92	98	90	68	88
92										76	87	90	87	65	92
96											75	81	82	63	96
100											51	70	74	60	100
104												54	66	57	104
108													54	55	108
112													35	50	112
116														40,5	116

VKTAB 190083

m	54 m													m	
	36 m	42 m	48 m	54 m	60 m	66 m	72 m	78 m	84 m	90 m	96 m	102 m	108 m		114 m
16	574														16
18	562	496													18
20	548	487	433	381											20
22	532	478	428	380	338										22
24	516	466	420	376	333	294									24
26	493	455	411	369	329	291	257	227							26
28	470	439	401	362	325	287	254	224	198	184					28
30	445	421	392	355	319	284	252	222	196	183	148				30
32	419	402	378	349	314	281	248	220	195	181	146	136	120		32
34	387	381	363	339	309	276	246	218	193	180	143	134	119	106	34
36	356	360	347	329	303	272	242	216	191	178	140	133	118	104	36
38	319	335	330	318	294	269	238	214	188	177	138	131	117	103	38
40		310	312	304	287	261	233	212	186	175	135	129	115	101	40
44		256	273	275	266	248	223	206	181	172	130	125	113	98	44
48			234	244	242	231	212	202	176	169	125	122	111	95	48
52				213	217	213	197	197	169	163	120	118	108	92	52
56				182	191	194	180	186	162	157	116	115	106	89	56
60					163	175	167	174	155	150	112	112	103	86	60
64						152	154	160	148	141	108	109	101	83	64
68						119	138	145	139	133	105	106	98	80	68
72							122	129	129	126	102	104	95	77	72
76							83	114	118	118	100	102	93	74	76
80								94	105	111	97	100	91	72	80
84									91	104	95	98	88	68	84
88									64	96	91	96	86	66	88
92										82	88	90	84	63	92
96											80	83	80	61	96
100											57	74	75	58	100
104												61	71	56	104
108													61	53	108
112													41	51	112
116														45,5	116

VKTAB 190083

Traglasten am SDWB-Auslegersystem

Lifting capacities on SDWB boom/jib combination

Forces de levage en configuration SDWB · Portate con sistema braccio SDWB

Tablas de carga con sistema de pluma SDWB · Грузоподъемность на стреловой системе SDWB



max. 600 t
x max. 25 m

Vorläufig
Préliminaire · Provisorio
Provisional · Временно
Preliminary

m	60 m													m	
	36 m	42 m	48 m	54 m	60 m	66 m	72 m	78 m	84 m	90 m	96 m	102 m	108 m		114 m
18	517	459													18
20	505	452	404												20
22	489	442	398	355	316										22
24	473	432	390	349	313	276									24
26	453	418	383	345	308	274	242	212							26
28	435	405	372	339	304	270	239	212	188	176					28
30	414	390	362	331	300	266	237	210	186	175	143				30
32	392	375	350	323	293	263	234	208	184	174	141	131	115		32
34	372	358	338	312	287	259	231	206	183	172	138	130	115	102	34
36	352	341	325	303	282	255	228	203	181	171	136	128	114	100	36
38	321	325	310	294	273	251	225	201	180	169	134	126	113	99	38
40		311	297	283	265	246	220	199	177	168	131	125	112	98	40
44		262	272	261	249	235	212	194	172	165	126	121	109	95	44
48			240	241	230	220	203	189	167	162	122	118	107	92	48
52				217	212	205	191	183	161	158	117	115	104	89	52
56				184	194	191	177	174	155	153	114	112	102	86	56
60					165	177	164	163	149	148	110	109	99	83	60
64						155	152	153	142	140	106	106	97	80	64
68						124	138	143	135	133	103	103	94	78	68
72							122	131	128	126	100	101	92	75	72
76							90	115	120	119	97	99	89	72	76
80								98	106	112	95	97	87	69	80
84									93	105	92	95	85	66	84
88									71	99	90	93	82	64	88
92										86	87	88	80	61	92
96											81	82	78	59	96
100											62	75	74	56	100
104												64	71	54	104
108													63	52	108
112													45	49,5	112
116														46	116

VKTAB 190083

m	66 m													m	
	36 m	42 m	48 m	54 m	60 m	66 m	72 m	78 m	84 m	90 m	96 m	102 m	108 m		114 m
18	475	425													18
20	464	416	374												20
22	451	409	367	331											22
24	434	401	362	325	293	259									24
26	414	385	355	321	290	256	228								26
28	397	371	342	315	284	254	226	200	179						28
30	380	357	332	306	280	249	224	198	178	166	138				30
32	363	344	321	297	274	246	222	196	175	165	136	126			32
34	346	329	310	289	266	242	218	194	174	164	134	125	111	98	34
36	329	315	299	280	259	238	216	193	172	162	131	123	109	97	36
38	311	301	286	272	252	232	212	190	171	161	129	122	108	95	38
40		288	274	262	246	226	209	187	169	160	127	120	107	94	40
44		251	253	243	231	215	200	183	164	157	122	117	105	91	44
48			228	224	216	203	191	175	159	153	118	114	103	89	48
52				205	200	191	181	168	154	150	114	111	100	86	52
56				185	185	178	170	160	148	146	110	108	98	83	56
60					163	166	160	151	142	141	107	105	95	80	60
64						149	149	142	135	135	103	102	93	77	64
68						126	136	133	128	129	100	100	90	75	68
72							121	123	121	123	97	98	88	72	72
76							90	111	113	117	95	95	86	69	76
80								97	103	110	93	93	83	67	80
84									94	103	90	90	81	64	84
88									75	97	87	88	79	61	88
92										85	85	84	77	59	92
96											80	78	74	56	96
100											64	73	70	54	100
104												64	66	52	104
108													61	49,5	108
112													47	47,5	112
116														45,5	116

VKTAB 190083

Traglasten am SDWB-Auslegersystem

Lifting capacities on SDWB boom/jib combination

Forces de levage en configuration SDWB · Portate con sistema braccio SDWB

Tablas de carga con sistema de pluma SDWB · Грузоподъемность на стреловой системе SDWB

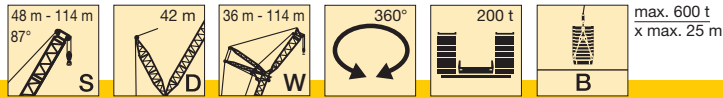

Vorläufig
Préliminaire · Provisorio
Провизорно · временно
Preliminary

m	72 m													m	
	36 m	42 m	48 m	54 m	60 m	66 m	72 m	78 m	84 m	90 m	96 m	102 m	108 m		114 m
18	439														18
20	427														20
22	414	387	347												22
24	397	367	334	307											24
26	380	355	325	296	269	240	215								26
28	365	340	316	289	263	237	212	188	167						28
30	350	328	306	281	257	234	210	186	167	158	131				30
32	337	316	294	274	251	228	208	184	165	156	130	121			32
34	322	305	285	266	245	224	205	182	164	155	128	119	106		34
36	308	294	275	256	239	219	201	181	162	153	126	118	105	93	36
38	293	282	266	248	232	214	197	178	161	152	124	117	104	91	38
40		269	257	241	225	209	193	175	159	151	122	115	103	90	40
44		248	238	225	212	197	185	169	154	148	118	112	101	88	44
48			219	209	199	186	175	162	150	144	114	109	99	85	48
52				194	186	176	166	154	144	141	111	107	96	82	52
56				180	172	165	157	147	138	136	107	104	94	80	56
60					160	153	148	139	131	131	104	101	91	77	60
64						143	138	131	125	126	100	98	89	74	64
68						132	129	123	118	120	97	96	86	72	68
72							121	115	111	114	94	94	84	69	72
76							98	108	104	108	92	92	82	67	76
80								98	98	102	90	89	79	64	80
84								62	91	96	88	85	77	61	84
88									79	91	84	82	75	59	88
92										85	80	78	73	56	92
96										61	76	73	70	54	96
100											67	68	66	52	100
104												64	62	49,5	104
108													45,5	58	108
112														49,5	112
116														44	116
120														33	120

VKTAB 190083

m	78 m													m	
	36 m	42 m	48 m	54 m	60 m	66 m	72 m	78 m	84 m	90 m	96 m	102 m	108 m		114 m
18	402														18
20	391	355	318												20
22	378	345	315	285											22
24	364	334	308	281	252										24
26	350	323	297	274	248	224	201								26
28	337	312	288	266	243	221	198	178							28
30	321	301	280	259	237	217	196	176	157	149					30
32	309	288	271	251	230	212	193	174	156	148	125	117			32
34	297	278	262	244	225	207	189	172	154	146	123	115	101		34
36	285	268	251	237	219	202	186	169	152	145	121	114	100	88	36
38	274	258	243	230	213	197	181	167	150	143	119	113	99	87	38
40		249	235	221	207	193	177	164	148	142	117	112	98	86	40
44		230	219	208	194	183	169	156	143	139	113	109	96	84	44
48			203	194	183	173	161	150	137	135	110	106	94	81	48
52				180	171	163	153	143	132	130	106	103	91	79	52
56				168	159	153	144	137	127	125	103	101	89	76	56
60					149	143	136	129	121	121	100	99	87	73	60
64					138	133	128	122	115	116	96	96	84	71	64
68						124	119	115	109	112	94	94	82	68	68
72							111	107	102	107	91	92	79	66	72
76							103	101	96	100	89	89	77	63	76
80								94	90	95	87	87	75	61	80
84								70	84	89	85	83	73	59	84
88									78	84	80	79	71	56	88
92										80	76	74	68	53	92
96										64	71	70	66	51	96
100											65	65	62	49	100
104												61	58	47	104
108													48	54	108
112														47,5	112
116														42	116
120														34	120

VKTAB 190083

Traglasten am SDWB-Auslegersystem

Lifting capacities on SDWB boom/jib combination

Forces de levage en configuration SDWB · Portate con sistema braccio SDWB

Tablas de carga con sistema de pluma SDWB · Грузоподъемность на стреловой системе SDWB



max. 600 t
x max. 25 m

Vorläufig
Préliminaire · Provisorio
Provisional · Временно
Preliminary

m	84 m														m
	36 m	42 m	48 m	54 m	60 m	66 m	72 m	78 m	84 m	90 m	96 m	102 m	108 m	114 m	
18	365														18
20	356	324													20
22	344	316	288	260											22
24	330	307	281	255	231										24
26	317	295	273	249	227	205	183								26
28	306	285	263	243	222	201	182	163							28
30	294	275	255	237	217	197	178	162	145	138					30
32	283	265	247	228	212	193	176	159	143	137	119	109			32
34	272	256	239	222	205	189	173	157	142	136	118	109	96		34
36	261	247	231	215	200	185	169	155	139	135	116	108	94	83	36
38	251	238	224	209	195	179	166	152	137	133	115	107	94	82	38
40		229	217	203	189	175	162	149	135	131	113	106	93	81	40
44		213	201	191	179	166	154	143	131	128	110	103	91	79	44
48			188	178	169	157	146	136	126	124	106	100	88	77	48
52			175	166	159	149	139	130	120	120	103	98	86	74	52
56				155	148	141	132	124	115	114	100	96	84	72	56
60					138	131	125	118	110	110	97	93	82	69	60
64					129	123	118	112	105	106	94	91	79	67	64
68						115	110	106	100	102	91	88	77	65	68
72							102	100	94	98	89	85	75	62	72
76							96	93	89	93	86	82	73	60	76
80								87	83	88	83	79	70	58	80
84								72	78	83	80	76	68	55	84
88									73	79	76	72	66	53	88
92										74	72	69	63	50	92
96										65	67	64	61	48	96
100											62	60	57	46	100
104												56	53	44,5	104
108												48	49	42,5	108
112													45	41	112
116														39,5	116
120														34	120

VKTAB 190083

m	90 m													m
	42 m	48 m	54 m	60 m	66 m	72 m	78 m	84 m	90 m	96 m	102 m	108 m	114 m	
20	294													20
22	286	260	233											22
24	278	254	232	210										24
26	269	247	227	206	186									26
28	260	240	222	202	183	167	149							28
30	250	233	216	197	179	164	147	132	127					30
32	241	224	210	193	176	161	145	130	126	113				32
34	233	217	204	188	172	158	143	129	124	111	101	88		34
36	225	210	197	183	168	156	141	127	123	110	101	88	78	36
38	218	204	191	177	164	152	138	125	122	108	100	87	77	38
40	211	198	186	172	160	149	136	123	121	107	99	86	76	40
44	198	186	175	162	151	142	130	119	117	104	97	85	74	44
48		174	165	154	143	134	125	114	113	101	95	83	72	48
52		163	156	145	135	128	118	110	109	98	92	81	70	52
56			146	137	128	121	112	104	105	95	90	78	68	56
60				129	121	115	107	99	100	92	87	76	65	60
64				119	114	109	102	95	96	89	84	74	63	64
68					107	103	97	90	93	86	81	72	61	68
72					94	97	91	85	89	83	77	70	58	72
76						91	86	81	85	80	75	67	56	76
80							80	76	81	77	72	65	54	80
84							71	71	77	74	69	62	52	84
88								66	72	70	66	60	49,5	88
92									68	66	62	57	47,5	92
96									63	61	58	55	45	96
100										58	55	51	43	100
104											51	48	41,5	104
108											47	44,5	39,5	108
112												41,5	38	112
116													35,5	116
120													33	120

VKTAB 190083

Traglasten am SDWB-Auslegersystem

Lifting capacities on SDWB boom/jib combination

Forces de levage en configuration SDWB · Portate con sistema braccio SDWB

Tablas de carga con sistema de pluma SDWB · Грузоподъемность на стреловой системе SDWB



Vorläufig
Préliminaire · Provisorio
Provisional · Временно
Preliminary

m	96 m													m
	42 m	48 m	54 m	60 m	66 m	72 m	78 m	84 m	90 m	96 m	102 m	108 m	114 m	
20	268													20
22	260	238												22
24	253	231	211	190										24
26	245	226	206	187	170									26
28	238	220	201	182	167	151	134							28
30	230	213	196	179	165	149	133	121	118					30
32	221	207	191	175	161	147	132	120	117	104				32
34	214	201	186	171	158	143	130	119	115	103	93	80		34
36	207	193	181	166	154	141	128	117	114	102	92	81	72	36
38	200	187	176	162	151	138	125	116	113	101	91	80	71	38
40	194	182	169	157	147	135	123	113	112	100	90	79	70	40
44	182	171	160	148	139	129	118	109	108	98	88	78	69	44
48		161	151	140	131	123	113	105	105	95	86	76	67	48
52		152	142	132	125	116	108	101	101	92	84	74	65	52
56			134	125	118	110	102	96	98	89	82	72	63	56
60			127	118	112	105	97	91	94	86	79	70	61	60
64				111	106	100	92	87	90	83	76	68	59	64
68					100	94	88	83	86	80	73	66	57	68
72					94	89	83	79	83	76	70	63	54	72
76						84	78	75	79	73	68	61	52	76
80							74	71	76	70	65	59	50	80
84							69	66	72	67	62	56	48	84
88								63	68	64	60	54	46	88
92									64	61	57	52	44	92
96									62	57	54	49,5	42	96
100										54	51	47	40	100
104											48	44,5	38,5	104
108											46	42	36,5	108
112												39,5	35	112
116													33,5	116
120													32	120

VKTAB 190083

m	102 m											m		
	48 m	54 m	60 m	66 m	72 m	78 m	84 m	90 m	96 m	102 m	108 m		114 m	
22	214													22
24	210	190	170											24
26	204	186	170	153										26
28	199	182	167	151	136									28
30	193	177	164	148	134	120	110							30
32	188	173	159	146	132	118	108	106	95					32
34	182	168	155	142	130	117	107	105	94	85				34
36	177	164	152	139	127	115	106	104	93	84	74	65		36
38	171	159	148	136	124	113	104	103	92	83	73	65		38
40	166	155	144	132	121	110	102	101	91	82	72	64		40
44	155	146	136	126	116	105	98	98	89	80	70	62		44
48	146	137	129	120	111	101	94	94	86	78	69	61		48
52	139	129	121	114	105	96	90	91	83	75	67	60		52
56		122	114	107	100	92	86	88	80	73	65	58		56
60		117	108	101	94	87	82	84	77	70	62	56		60
64			103	96	89	82	78	81	74	68	60	54		64
68				91	85	78	74	78	71	65	58	52		68
72				87	80	74	70	75	69	63	56	50		72
76					76	70	67	71	66	60	54	48		76
80						67	63	68	63	58	52	46		80
84							63	60	65	60	56	50	44,5	84
88								57	62	57	53	48	42,5	88
92									59	55	50	45,5	40,5	92
96									57	52	48	43,5	39	96
100										49,5	45,5	41,5	37	100
104											43,5	39,5	35	104
108											41,5	37,5	33,5	108
112												35,5	32	112
116													30,5	116
120													28,7	120

VKTAB 190083

Traglasten am SDWB-Auslegersystem

Lifting capacities on SDWB boom/jib combination

Forces de levage en configuration SDWB · Portate con sistema braccio SDWB

Tablas de carga con sistema de pluma SDWB · Грузоподъемность на стреловой системе SDWB



max. 600 t
x max. 25 m

Vorläufig
Préliminaire · Provisorio
Provisional · Временно
Preliminary

m	108 m											m
	54 m	60 m	66 m	72 m	78 m	84 m	90 m	96 m	102 m	108 m	114 m	
24	172											24
26	169											26
28	165	152	137									28
30	162	150	135	122								30
32	157	147	133	120	109	97						32
34	153	144	131	118	108	97	96	85				34
36	150	140	128	116	106	96	95	85	76			36
38	146	137	126	114	105	94	94	84	76	66	60	38
40	141	133	122	112	103	93	93	83	75	66	60	40
44	133	130	119	109	101	91	91	82	74	65	59	44
48	126	123	114	104	97	88	89	80	72	63	58	48
52	119	116	108	100	93	84	86	78	70	62	57	52
56	113	110	102	94	89	81	82	75	68	60	55	56
60	107	104	96	90	84	78	80	72	66	58	54	60
64		98	91	85	80	74	77	70	63	56	52	64
68		93	87	81	76	70	73	67	61	54	51	68
72		79	82	76	72	66	70	64	59	52	48,5	72
76			78	72	68	63	67	62	56	50	46,5	76
80				68	65	60	64	59	54	48	44,5	80
84				67	61	57	61	57	52	46	43	84
88					58	53	59	54	49,5	44,5	41	88
92						50	56	51	47	42,5	39	92
96						49	53	49	45	40,5	37,5	96
100							51	46,5	43	38,5	35,5	100
104								44	40,5	36,5	34	104
108								43	38,5	34,5	32,5	108
112									36,5	33	31	112
116										31	29,8	116
120										29,9	28,2	120
											26,7	120

VKTAB 190083

m	114 m										m	
	54 m	60 m	66 m	72 m	78 m	84 m	90 m	96 m	102 m	108 m		
24	153											24
26	150											26
28	147	135	122									28
30	143	133	122	110								30
32	140	130	119	108	97							32
34	136	127	117	106	95	86						34
36	133	124	114	104	94	85	86	85	76	68		36
38	130	121	112	102	92	83	84	84	75	67	61	38
40	127	118	110	100	90	81	82	82	74	66	60	40
44	120	115	107	98	89	80	81	81	73	65	59	44
48	113	110	102	94	85	77	78	78	70	63	58	48
52	107	104	98	90	82	74	76	76	68	61	56	52
56	101	98	93	86	78	71	73	73	66	59	54	56
60	97	93	87	82	74	68	70	70	64	57	53	60
64		88	83	77	71	65	68	68	61	55	51	64
68		84	79	73	67	61	65	65	59	53	49	68
72		77	75	69	63	58	62	62	57	51	47,5	72
76			71	66	60	55	59	59	54	49	45,5	76
80				63	57	52	57	57	52	47	44	80
84				61	54	49,5	54	54	49,5	44,5	42	84
88					51	47	47	47	47	42,5	40,5	88
92						44,5	49,5	49,5	45	40,5	38	92
96						42,5	47,5	47,5	43	38,5	36,5	96
100							45	45	41	37	34,5	100
104									39	35,5	33,5	104
108									38	33,5	32	108
112										32	30,5	112
116											28,7	116
											27,7	116

VKTAB 190083

Traglasten am SDWB2-Auslegersystem

Lifting capacities on SDWB2 boom/jib combination

Forces de levage en configuration SDWB2 · Portate con sistema braccio SDWB2

Tablas de carga con sistema de pluma SDWB2 · Грузоподъемность на стреловой системе SDWB2

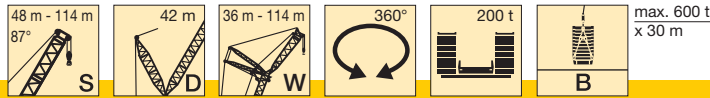

Vorläufig
Préliminaire · Provisorio
Provisional · Временно
Preliminary

m	48 m													m	
	36 m	42 m	48 m	54 m	60 m	66 m	72 m	78 m	84 m	90 m	96 m	102 m	108 m		114 m
16	628														16
18	620	539													18
20	607	533	469	412											20
22	588	522	464	407	359										22
24	566	512	458	402	356	312	274								24
26	528	500	449	397	351	309	272	238							26
28	489	474	440	389	346	305	270	237	208	193					28
30	450	440	428	383	342	301	267	235	207	191	153				30
32	412	409	401	377	336	298	264	233	205	190	150	141	124		32
34	378	379	375	359	331	294	261	231	203	188	147	139	122	109	34
36	343	351	352	340	323	290	256	228	201	186	144	137	121	107	36
38	304	326	329	320	308	286	251	226	199	185	141	135	120	106	38
40		301	306	302	293	276	247	224	196	183	138	133	118	104	40
44			267	266	264	259	234	220	191	179	133	129	116	101	44
48			226	237	234	235	219	214	185	176	128	126	114	98	48
52				207	210	210	202	208	177	169	123	122	112	95	52
56				170	184	190	185	190	169	162	119	119	109	92	56
60					153	170	170	172	162	153	115	116	107	89	60
64						145	155	157	154	144	111	112	104	86	64
68						105	134	142	142	135	107	110	102	83	68
72							110	126	129	127	104	107	99	80	72
76							72	109	115	119	101	105	97	77	76
80								87	101	111	99	102	94	74	80
84									85	103	96	100	92	71	84
88									56	94	92	98	90	68	88
92										75	87	90	88	65	92
96											75	81	82	63	96
100											50	70	74	60	100
104												54	66	58	104
108													54	55	108
112													35	50	112
116														40	116

VKTAB 190084

m	54 m													m	
	36 m	42 m	48 m	54 m	60 m	66 m	72 m	78 m	84 m	90 m	96 m	102 m	108 m		114 m
16	575														16
18	567	499													18
20	554	491	436	384											20
22	540	483	429	381	338										22
24	525	472	423	376	334	294									24
26	504	461	415	371	329	291	256	226							26
28	481	447	406	365	325	288	254	224	198	184					28
30	453	430	397	358	321	284	252	222	196	182	148				30
32	423	410	384	351	316	281	249	220	195	181	146	136	120		32
34	389	385	370	343	312	277	246	218	193	179	143	134	119	105	34
36	355	360	352	333	306	274	242	216	191	178	140	132	118	104	36
38	318	335	332	323	297	270	238	214	189	177	137	131	116	102	38
40		309	312	307	290	263	234	212	187	175	135	129	115	101	40
44		255	273	275	268	249	224	207	181	172	130	125	113	98	44
48			233	244	242	232	213	203	176	168	125	122	111	95	48
52				213	216	213	197	199	169	163	120	119	108	92	52
56				182	190	194	181	186	163	157	116	115	106	89	56
60					163	175	167	174	156	150	112	112	103	86	60
64						153	154	160	148	142	109	109	101	83	64
68						118	138	144	139	133	105	107	98	80	68
72							122	129	129	126	102	104	95	77	72
76							81	114	118	118	100	102	93	75	76
80								94	105	111	97	100	91	72	80
84									91	104	95	98	88	69	84
88									63	96	91	97	86	66	88
92										82	88	90	84	64	92
96											80	83	81	61	96
100											56	74	76	58	100
104												60	70	56	104
108													61	53	108
112													40,5	51	112
116														44,5	116

VKTAB 190084

Traglasten am SDWB2-Auslegersystem

Lifting capacities on SDWB2 boom/jib combination

Forces de levage en configuration SDWB2 · Portate con sistema braccio SDWB2

Tablas de carga con sistema de pluma SDWB2 · Грузоподъемность на стреловой системе SDWB2



Vorläufig
Préliminaire · Provisorio
Provisional · Временно
Preliminary

m	60 m													m	
	36 m	42 m	48 m	54 m	60 m	66 m	72 m	78 m	84 m	90 m	96 m	102 m	108 m		114 m
18	518	461													18
20	509	453	404												20
22	494	445	398	355	315										22
24	477	436	392	349	313	276									24
26	459	423	386	345	309	273	241	213							26
28	441	409	376	340	304	270	239	212	187	176					28
30	419	395	366	333	299	267	237	210	186	175	143				30
32	397	380	352	325	294	263	234	208	184	173	141	131	115		32
34	379	363	341	316	289	260	231	206	183	172	138	129	115	101	34
36	360	345	328	305	284	256	228	204	181	171	136	128	113	100	36
38	323	329	315	296	276	253	224	201	179	169	133	126	112	99	38
40		312	301	285	268	248	221	199	178	168	131	124	111	97	40
44		261	275	263	251	237	213	195	172	165	126	121	109	94	44
48			240	243	232	222	204	190	167	162	122	118	107	92	48
52				218	213	206	191	185	161	158	117	115	104	89	52
56				184	193	191	177	175	156	154	114	112	102	86	56
60					164	177	165	165	149	148	110	109	99	83	60
64						154	152	155	142	141	106	106	97	80	64
68						123	138	145	135	133	103	103	94	78	68
72							122	132	128	126	100	101	92	75	72
76							87	115	120	119	97	99	89	72	76
80								98	106	112	95	97	87	69	80
84									92	105	93	95	85	67	84
88									69	99	90	94	83	64	88
92										86	88	89	81	61	92
96											81	82	78	59	96
100											61	75	74	56	100
104												64	70	54	104
108													62	52	108
112													44,5	49,5	112
116														45	116

VKTAB 190084

m	66 m													m	
	36 m	42 m	48 m	54 m	60 m	66 m	72 m	78 m	84 m	90 m	96 m	102 m	108 m		114 m
18	477	424													18
20	466	418	374												20
22	454	409	369	330	295										22
24	437	401	361	327	293	258									24
26	420	388	355	320	289	256	228								26
28	402	375	344	314	285	253	226	199	178						28
30	383	362	334	307	280	250	224	198	177	166	138				30
32	366	348	324	299	274	246	221	196	175	165	136	126			32
34	349	332	313	291	267	242	219	194	174	163	133	125	110	97	34
36	332	317	302	282	261	237	215	192	172	162	131	123	109	96	36
38	311	304	290	274	254	232	212	190	171	161	129	121	108	95	38
40		290	278	265	248	227	209	187	169	159	127	120	107	94	40
44		249	255	246	233	217	201	182	164	157	122	117	105	91	44
48			230	227	218	205	192	176	159	154	118	114	103	88	48
52				207	203	192	182	169	154	150	114	111	100	86	52
56				185	188	180	172	161	149	146	110	108	98	83	56
60					164	167	161	152	142	142	107	105	95	80	60
64						150	150	143	136	136	104	103	93	77	64
68						125	136	135	129	130	100	100	90	75	68
72							121	124	122	123	97	98	88	72	72
76							89	112	114	117	95	95	85	69	76
80								97	104	110	93	93	83	67	80
84									94	104	90	91	81	64	84
88									73	97	88	89	79	61	88
92										85	86	85	77	59	92
96											80	80	74	57	96
100											63	74	71	54	100
104												63	67	52	104
108													61	49,5	108
112													46,5	47,5	112
116														45	116

VKTAB 190084

Traglasten am SDWB2-Auslegersystem

Lifting capacities on SDWB2 boom/jib combination

Forces de levage en configuration SDWB2 · Portate con sistema braccio SDWB2

Tablas de carga con sistema de pluma SDWB2 · Грузоподъемность на стреловой системе SDWB2

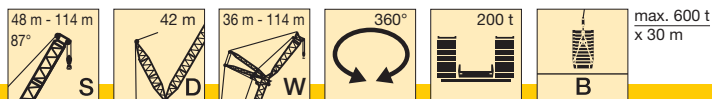

Vorläufig
Préliminaire · Provisorio
Provisional · Временно
Preliminary

m	72 m													m	
	36 m	42 m	48 m	54 m	60 m	66 m	72 m	78 m	84 m	90 m	96 m	102 m	108 m		114 m
18	438														18
20	426														20
22	413	386	346												22
24	398	366	336	306											24
26	383	354	325	297	268	239	214								26
28	368	342	315	288	264	236	212	187	167						28
30	354	330	306	281	258	233	209	185	166	157	132				30
32	341	318	296	273	251	229	207	184	165	156	130	121			32
34	326	307	287	265	245	223	204	182	163	154	128	119	105		34
36	311	296	277	258	239	218	202	180	162	153	126	118	105	92	36
38	297	285	268	250	232	213	196	178	160	152	124	116	104	91	38
40		273	258	242	226	208	192	175	159	151	122	115	102	90	40
44		251	239	227	213	198	184	168	155	148	118	112	100	87	44
48			221	211	200	188	176	162	149	145	114	109	98	85	48
52				195	187	177	167	155	144	140	110	106	96	82	52
56				181	174	166	158	148	138	136	107	104	93	79	56
60					161	155	149	140	132	131	103	101	91	77	60
64						144	139	132	126	126	100	99	89	74	64
68						132	130	124	119	121	97	96	86	72	68
72							122	116	112	115	94	94	84	69	72
76							97	109	105	109	92	92	81	66	76
80								98	99	103	90	89	79	64	80
84								61	92	98	88	86	77	61	84
88									78	92	85	82	75	59	88
92										85	81	78	73	56	92
96										60	77	74	71	54	96
100											67	69	67	51	100
104												64	63	49,5	104
108												44,5	59	47,5	108
112													49	45,5	112
116														43,5	116
120														33	120

VKTAB 190084

m	78 m													m	
	36 m	42 m	48 m	54 m	60 m	66 m	72 m	78 m	84 m	90 m	96 m	102 m	108 m		114 m
18	401														18
20	393	354	319												20
22	377	346	314	284											22
24	363	336	307	280	251										24
26	349	322	298	273	247	223	199								26
28	336	312	288	267	242	220	197	177							28
30	323	301	279	260	237	216	195	175	156	148					30
32	311	290	270	251	231	212	192	173	155	147	124	116			32
34	299	280	261	243	224	208	189	171	153	146	122	115	101		34
36	287	270	252	236	218	203	185	169	152	144	121	114	100	88	36
38	276	260	245	229	212	197	182	166	150	143	119	112	99	87	38
40		250	237	222	206	192	178	163	148	142	117	111	98	86	40
44		232	220	209	195	182	169	157	143	138	113	108	96	83	44
48			204	196	184	173	161	150	138	135	110	106	93	81	48
52				182	173	164	153	143	132	130	106	103	91	78	52
56				169	161	154	145	137	126	125	103	101	89	76	56
60					150	144	137	130	121	121	100	98	87	73	60
64					138	135	128	123	115	116	97	96	84	71	64
68						125	120	116	110	112	94	94	82	68	68
72							112	108	103	106	91	91	80	66	72
76							103	102	97	101	89	89	78	63	76
80								95	91	95	87	86	75	61	80
84								68	85	90	84	82	73	58	84
88									80	85	81	78	70	56	88
92										80	76	74	68	54	92
96										63	71	70	65	51	96
100											64	65	62	49	100
104												61	58	47	104
108												47,5	54	45	108
112													47	43,5	112
116														41,5	116
120														34	120

VKTAB 190084

Traglasten am SDWB2-Auslegersystem

Lifting capacities on SDWB2 boom/jib combination

Forces de levage en configuration SDWB2 · Portate con sistema braccio SDWB2

Tablas de carga con sistema de pluma SDWB2 · Грузоподъемность на стреловой системе SDWB2



max. 600 t
x 30 m

Vorläufig
Préliminaire · Provisorio
Provisional · Временно
Preliminary

m	84 m														m
	36 m	42 m	48 m	54 m	60 m	66 m	72 m	78 m	84 m	90 m	96 m	102 m	108 m	114 m	
18	363														18
20	355	323													20
22	343	315	287	258											22
24	331	305	280	254	229										24
26	317	296	272	248	226	202	181								26
28	305	284	264	242	222	200	179	161							28
30	293	274	256	236	217	197	177	160	143	137					30
32	282	264	246	229	212	193	174	158	141	135	119	110			32
34	272	255	239	223	206	189	172	156	140	134	118	109	95		34
36	263	247	231	215	201	184	169	154	138	133	116	107	94	83	36
38	253	238	224	208	195	180	165	151	137	132	114	106	93	82	38
40		230	216	202	189	176	162	149	135	130	112	105	92	81	40
44		214	202	190	178	166	154	143	130	127	109	103	90	78	44
48			189	178	168	157	146	137	126	123	106	100	88	76	48
52			176	167	159	149	139	130	121	119	103	98	86	74	52
56				156	149	140	132	124	115	115	100	95	83	72	56
60					139	132	125	118	110	111	97	93	81	69	60
64					130	123	117	112	105	106	94	91	79	67	64
68						115	110	106	99	102	91	89	77	64	68
72							103	99	94	97	88	85	75	62	72
76							97	93	88	92	86	82	73	60	76
80								87	83	88	83	79	71	57	80
84								70	77	83	80	75	68	55	84
88									73	78	76	72	66	53	88
92										74	72	68	63	51	92
96										64	67	64	60	48,5	96
100											62	60	57	46,5	100
104												56	53	44,5	104
108												48	49	42,5	108
112													44,5	40,5	112
116														39	116
120														34,5	120

VKTAB 190084

m	90 m													m
	42 m	48 m	54 m	60 m	66 m	72 m	78 m	84 m	90 m	96 m	102 m	108 m	114 m	
20	292													20
22	285	259	235											22
24	277	253	231	207										24
26	268	247	226	204	183									26
28	260	240	221	201	181	164	147							28
30	251	233	216	196	178	162	145	130	126					30
32	243	226	210	192	175	160	143	129	124	112				32
34	233	219	204	187	171	157	142	127	123	111	101	88		34
36	225	211	198	183	168	155	139	126	122	109	100	87	78	36
38	217	204	192	178	164	152	137	124	120	108	99	86	77	38
40	210	197	186	173	160	148	135	122	119	106	98	86	76	40
44	197	185	175	162	152	142	130	118	116	103	96	84	74	44
48		174	165	153	143	135	124	114	112	100	94	82	71	48
52		162	155	145	135	129	119	109	109	97	91	80	69	52
56			145	136	128	121	113	104	105	95	89	78	67	56
60				128	121	115	107	100	101	92	86	76	65	60
64				118	113	109	101	94	97	89	84	74	63	64
68					106	102	96	90	93	87	81	72	60	68
72					90	96	91	85	88	84	78	70	58	72
76						90	85	80	84	80	75	67	56	76
80							80	75	80	77	72	65	54	80
84							70	71	76	73	68	63	51	84
88								66	72	69	65	60	49,5	88
92									67	65	62	57	47,5	92
96									63	61	58	54	45,5	96
100										57	54	51	43,5	100
104											51	47,5	41,5	104
108											47	44,5	40	108
112												41,5	38	112
116													35,5	116
120													34	120

VKTAB 190084

Traglasten am SDWB2-Auslegersystem

Lifting capacities on SDWB2 boom/jib combination

Forces de levage en configuration SDWB2 · Portate con sistema braccio SDWB2

Tablas de carga con sistema de pluma SDWB2 · Грузоподъемность на стреловой системе SDWB2

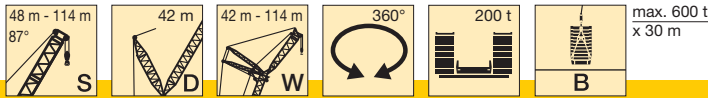

Vorläufig
Préliminaire · Provisorio
Provisional · Временно
Preliminary

m	96 m													m
	42 m	48 m	54 m	60 m	66 m	72 m	78 m	84 m	90 m	96 m	102 m	108 m	114 m	
20	265													20
22	259	235												22
24	253	231	209	188										24
26	245	225	205	185	168									26
28	238	220	201	182	165	149	134							28
30	231	214	197	178	163	147	132	120	117					30
32	223	207	191	175	160	145	130	119	116	104				32
34	216	201	186	171	157	143	129	117	115	103	92	81		34
36	209	195	181	166	154	140	127	116	113	101	92	80	71	36
38	200	189	176	162	151	138	125	114	112	100	90	79	71	38
40	194	183	171	158	147	135	122	113	111	99	90	79	70	40
44	183	171	161	149	140	129	118	109	108	97	88	77	69	44
48		161	151	141	133	123	113	105	105	95	86	75	67	48
52		152	142	132	126	117	108	101	101	92	83	73	65	52
56			134	125	118	112	103	97	98	89	81	72	63	56
60			127	118	112	105	98	92	94	86	79	70	61	60
64				111	106	100	92	88	91	83	76	68	59	64
68					100	94	88	84	87	80	74	66	56	68
72					91	89	83	79	83	77	71	64	54	72
76						83	78	75	80	74	68	61	52	76
80							73	71	76	71	66	59	50	80
84							68	66	72	67	63	57	48	84
88								62	68	64	60	55	46	88
92									64	61	57	53	44	92
96									62	57	54	50	42,5	96
100										54	51	47	40,5	100
104											48	44,5	39	104
108											46	42	37,5	108
112												39,5	35,5	112
116													33,5	116
120													32	120

VKTAB 190084

m	102 m											m		
	48 m	54 m	60 m	66 m	72 m	78 m	84 m	90 m	96 m	102 m	108 m		114 m	
22	211												22	
24	207	187	170										24	
26	202	184	168	151									26	
28	198	180	165	149	134								28	
30	193	176	162	146	132	119	109						30	
32	187	172	158	144	130	117	107	105	94				32	
34	182	168	155	141	128	115	106	104	93	84			34	
36	177	164	151	138	126	113	104	103	92	83	73	64	36	
38	171	159	148	135	124	112	103	101	91	82	72	64	38	
40	166	155	144	132	121	110	101	100	90	81	71	63	40	
44	157	146	136	126	116	105	98	97	88	79	70	62	44	
48	147	138	129	120	111	101	94	94	85	77	68	60	48	
52	139	130	122	114	105	97	90	91	83	75	66	59	52	
56		122	116	108	100	92	87	88	80	73	64	57	56	
60		116	109	102	95	88	83	85	78	70	62	56	60	
64			103	96	90	83	79	82	75	68	60	54	64	
68				91	86	79	75	78	72	66	59	52	68	
72				86	80	75	71	75	69	63	57	50	72	
76					76	70	68	72	66	61	54	48	76	
80						66	64	69	64	58	52	46	80	
84							63	60	66	61	56	50	44	84
88								56	62	58	54	48,5	42,5	88
92									59	55	51	46	40,5	92
96									57	53	48,5	44	39	96
100										50	46	42	37	100
104											44	40	35,5	104
108											42	38	34	108
112												35,5	32,5	112
116													30,5	116
120													29,1	120

VKTAB 190084

Traglasten am SDWB2-Auslegersystem

Lifting capacities on SDWB2 boom/jib combination

Forces de levage en configuration SDWB2 · Portate con sistema braccio SDWB2

Tablas de carga con sistema de pluma SDWB2 · Грузоподъемность на стреловой системе SDWB2



max. 600 t
x 30 m

Vorläufig
Préliminaire · Provisorio
Provisional · Временно
Preliminary

m	108 m											m
	54 m	60 m	66 m	72 m	78 m	84 m	90 m	96 m	102 m	108 m	114 m	
24	170											24
26	167											26
28	164	151	137									28
30	161	148	134	121								30
32	157	146	132	119	109	98						32
34	153	143	130	117	107	97	96	85				34
36	150	140	127	115	106	95	95	85	76			36
38	146	137	125	113	104	94	94	84	75	66	60	38
40	142	133	122	111	102	92	92	83	74	65	60	40
44	134	130	119	109	100	91	91	82	74	65	59	44
48	127	124	114	105	97	88	88	79	72	63	58	48
52	120	117	109	100	93	84	85	77	70	61	57	52
56	114	111	103	95	89	81	83	75	68	60	55	56
60	108	105	98	91	85	78	80	72	66	58	53	60
64		100	93	86	81	74	77	70	63	56	52	64
68		95	88	82	77	71	74	67	61	54	50	68
72		77	83	77	73	67	71	65	59	52	48,5	72
76			79	73	69	64	68	62	57	51	46,5	76
80				69	66	61	65	60	55	48,5	44,5	80
84				67	62	57	62	57	52	47	42,5	84
88					58	54	59	55	50	45	41	88
92						51	57	52	48	43	39	92
96						49	54	49,5	45,5	41	37,5	96
100							51	47	43,5	39	35,5	100
104								44,5	41,5	37	34	104
108								43,5	39	35	32,5	108
112									37	33,5	31	112
116										31,5	29,7	116
120										30,5	28,5	120
											27,1	120

VKTAB 190084

m	114 m											m
	54 m	60 m	66 m	72 m	78 m	84 m	90 m	96 m	102 m	108 m	114 m	
24	152											24
26	149											26
28	146	135	123									28
30	143	132	122	110								30
32	140	130	119	108	97							32
34	137	127	117	106	96	86	86					34
36	133	124	115	104	94	85	85	76	68			36
38	130	121	112	102	92	83	84	75	67	60		38
40	127	118	110	100	90	82	83	74	66	60	53	40
44	120	116	108	98	89	80	81	73	65	59	53	44
48	114	110	103	94	85	77	78	71	64	58	51	48
52	108	105	98	90	82	74	76	68	61	56	50	52
56	102	99	93	86	78	71	73	66	59	54	48,5	56
60	98	94	88	82	74	68	70	64	57	53	47	60
64		89	84	78	71	65	68	61	55	51	45,5	64
68		85	79	74	68	62	65	59	53	49	44	68
72		78	76	70	64	59	63	57	51	47,5	42,5	72
76			72	67	61	56	60	54	49,5	45,5	40,5	76
80				63	58	53	57	52	47,5	44	39	80
84				62	55	50	55	50	45,5	42,5	37,5	84
88					52	47,5	52	47,5	43,5	40,5	36	88
92						45	50	45,5	41,5	38,5	34,5	92
96						43,5	48	43,5	39,5	37	33	96
100							46	41,5	37,5	35	31,5	100
104								39,5	36	33,5	30	104
108								38,5	34	32	28,9	108
112									32,5	30,5	27,6	112
116										29,2	26,4	116
120										28,2	25,1	120
											23,8	120

VKTAB 190084

Traglasten am SDWVB-Auslegersystem

Lifting capacities on SDWVB boom/jib combination

Forces de levage en configuration SDWVB · Portate con sistema braccio SDWVB

Tablas de carga con sistema de pluma SDWVB · Грузоподъемность на стреловой системе SDWVB

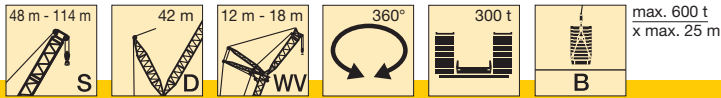

Vorläufig
Préliminaire · Provisorio
Provisional · Временно
Preliminary

m	48 m				54 m				60 m				m	
	12 m		18 m		12 m		18 m		12 m		18 m			
	12°	20°	12°	20°	12°	20°	12°	20°	12°	20°	12°	20°		
16	959	882			970					928				16
18	906	841	930		923	859	883			901	878	792		18
20	858	805	892	745	879	825	858	759		862	844	784		20
22	816	773	838	711	826	791	811	726		821	807	763	735	22
24	771	742	777	680	768	751	761	697		763	763	735	714	24
26	719	702	716	653	713	711	707	668		705	707	694	688	26
28	666	659	664	625	663	663	654	640		653	653	647	648	28
30	615	616	617	594	613	614	610	610		609	610	601	605	30
32	574	575	570	562	563	566	568	570		565	567	563	564	32
34	533	534	529	530	528	529	526	531		521	524	526	529	34
36	492	494	497	498	493	494	488	491		488	489	489	493	36
38	462	463	464	467	458	459	460	461		458	459	453	457	38
40	433	434	432	435	429	430	432	433		428	429	428	429	40
44	378	380	384	386	382	382	379	380		378	379	379	381	44
48	334	334	337	341	338	338	341	342		338	338	337	338	48
52	290	290	301	303	301	300	304	305		302	303	304	305	52
56	244	247	266	266	265	266	276	278		274	274	272	273	56
60	194	193	228	232	231	237	249	251		247	246	248	249	60
64			188	190	193	194	218	222		220	218	224	224	64
68			148				187	189		193	189	200	204	68
72							146			147		176	184	72
76												148	149	76

VKTAB 190086 / 190088

m	66 m				72 m				78 m				m	
	12 m		18 m		12 m		18 m		12 m		18 m			
	12°	20°	12°	20°	12°	20°	12°	20°	12°	20°	12°	20°		
18	813				725									18
20	799	778	700		718	697	626			642	623			20
22	776	760	691	659	707	688	621	592		630	618	558		22
24	744	736	683	654	697	681	606	588		623	604	549	530	24
26	693	694	674	645	667	668	604	582		613	602	544	523	26
28	643	646	634	633	628	629	589	577		589	586	539	519	28
30	600	600	593	595	589	591	564	561		565	562	523	516	30
32	561	562	554	557	553	554	539	537		541	539	509	500	32
34	522	523	521	522	518	519	513	512		510	511	495	487	34
36	482	485	487	490	483	485	483	485		479	480	474	473	36
38	452	453	454	458	448	451	453	456		448	449	447	450	38
40	426	427	421	426	420	421	423	427		417	419	420	423	40
44	374	374	377	378	374	375	372	373		369	371	367	371	44
48	334	335	333	335	328	330	333	335		328	329	329	330	48
52	300	300	300	301	297	298	294	296		291	293	294	296	52
56	269	270	271	272	267	267	268	270		264	265	262	264	56
60	245	245	243	245	241	242	242	243		238	237	239	241	60
64	220	221	223	224	220	220	218	220		215	216	216	217	64
68	196	201	204	203	199	199	200	202		197	197	196	197	68
72	172	178	184	183	180	179	182	183		179	178	180	181	72
76	148	146	165	164	161	159	165	167		163	163	164	165	76
80			144	147	141	142	151	152		148	149	149	151	80
84			111		110		137	138		134	134	133	139	84
88							114	113		112	111	118	124	88
92												104	104	92
96												80		96

VKTAB 190086 / 190088

Traglasten am SDWVB-Auslegersystem

Lifting capacities on SDWVB boom/jib combination

Forces de levage en configuration SDWVB · Portate con sistema braccio SDWVB

Tablas de carga con sistema de pluma SDWVB · Грузоподъемность на стреловой системе SDWVB



max. 600 t
x max. 25 m

Vorläufig
Préliminaire · Provisorio
Provisional · Временно
Preliminary

m	84 m				90 m				96 m				m	
	12 m		18 m		12 m		18 m		12 m		18 m			
	12°	20°	12°	20°	12°	20°	12°	20°	12°	20°	12°	20°		
20	572				519					459	449			20
22	569	555	501		511	499	453			455	446	402		22
24	559	547	496	476	500	495	446	429		448	440	398	386	24
26	552	541	483	474	494	481	438	426		444	436	392	384	26
28	540	536	483	468	488	480	433	420		438	433	390	378	28
30	527	521	476	464	478	469	427	415		424	421	387	376	30
32	514	509	468	456	471	465	417	412		426	421	377	374	32
34	500	498	462	451	465	458	413	401		426	421	377	374	34
36	472	473	456	446	453	452	407	398		421	416	374	365	36
38	444	446	438	440	430	430	401	393		409	409	369	363	38
40	417	418	415	417	408	408	386	386		390	390	365	359	40
44	364	365	367	371	362	363	353	354		353	354	337	338	44
48	327	328	324	326	323	325	320	322		315	317	310	311	48
52	291	291	293	295	290	291	290	291		286	287	282	284	52
56	261	262	262	264	258	258	261	263		256	257	257	258	56
60	237	237	236	237	234	235	233	235		227	229	231	233	60
64	213	213	215	216	212	213	212	214		208	209	205	207	64
68	193	194	194	195	191	191	193	194		189	189	189	190	68
72	177	177	176	178	174	175	175	175		170	169	172	173	72
76	161	160	162	163	160	160	158	160		154	156	155	156	76
80	145	147	148	148	145	144	145	147		141	142	141	142	80
84	130	135	134	134	131	131	132	133		128	128	129	130	84
88	114	119	122	121	119	118	119	121		116	117	118	118	88
92	101	101	109	108	106	105	109	111		106	107	107	107	92
96	78		97	98	95	95	100	100		97	96	97	98	96
100			82	82	80		90	91		87	87	89	89	100
104							79	78		77	75	81	80	104
108							55			55		72	71	108
112												56		112

VKTAB 190086 / 190088

m	102 m				108 m				114 m				m	
	12 m		18 m		12 m		18 m		12 m		18 m			
	12°	20°	12°	20°	12°	20°	12°	20°	12°	20°	12°	20°		
22	410				370					327				22
24	407	399	359		368	361	323			323	318	288		24
26	398	395	357	346	365	359	323			323	317	285	279	26
28	395	387	351	344	358	354	322	313		319	312	281	276	28
30	391	385	346	338	356	351	318	311		316	312	281	276	30
32	383	381	343	334	353	348	316	307		314	310	278	273	32
34	378	374	338	332	346	342	313	305		310	308	276	270	34
36	373	370	333	326	342	339	305	303		304	299	274	268	36
38	369	366	329	323	339	337	303	295		300	298	268	266	38
40	357	358	326	320	336	334	300	295		297	295	266	260	40
44	332	332	309	307	315	314	293	290		285	284	261	256	44
48	307	308	291	291	294	295	276	276		271	271	246	246	48
52	281	282	273	274	273	275	262	262		256	257	236	236	52
56	254	255	252	255	249	250	247	248		240	241	225	226	56
60	227	228	229	231	225	226	226	228		219	220	212	214	60
64	203	205	206	207	201	201	204	206		199	199	195	196	64
68	186	187	184	186	181	182	183	185		178	178	178	179	68
72	169	170	169	171	165	166	165	167		162	163	161	162	72
76	152	153	154	155	150	149	151	153		147	148	147	149	76
80	139	140	139	139	134	134	137	138		133	133	134	135	80
84	127	127	126	128	122	123	123	124		119	120	121	122	84
88	115	114	116	116	112	111	112	114		108	109	108	108	88
92	103	104	105	105	102	100	103	104		99	99	98	99	92
96	95	95	95	95	91	90	93	94		89	89	89	90	96
100	86	85	86	86	81	82	84	84		79	79	80	81	100
104	78	77	78	78	70	73	74	74		70	70	71	72	104
108	70	67	71	70	59	63	65	64		62	60	63	64	108
112	54		61	63	50	50	56	54		53	51	56	56	112
116			47	49	43	43	47	47		44,5	44,5	49,5	48,5	116
120			32		29,1		40,5	41		38,5	38	42,5	42	120
124							29,4			27,2		36	36	124
128												28,5	29,9	128
132												16,2		132

VKTAB 190086 / 190088

Traglasten am SDWVB2-Auslegersystem Lifting capacities on SDWVB2 boom/jib combination

Forces de levage en configuration SDWVB2 · Portate con sistema braccio SDWVB2

Tablas de carga con sistema de pluma SDWVB2 · Грузоподъемность на стреловой системе SDWVB2

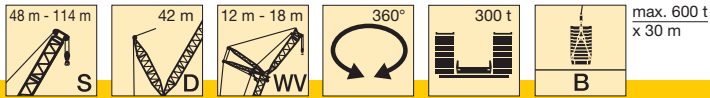

Vorläufig
Préliminaire · Provisorio
Provisional · Временно
Preliminary

m	48 m				54 m				60 m				m
	12 m		18 m		12 m		18 m		12 m		18 m		
	12°	20°	12°	20°	12°	20°	12°	20°	12°	20°	12°	20°	
16	963	885			978					891			16
18	909	844	934		926	863	911			891	883	815	18
20	861	808	896	746	882	828	891	761		891	849	810	20
22	821	775	844	713	841	795	861	729		860	819	800	22
24	778	745	801	682	804	767	825	699		820	790	788	24
26	744	719	759	655	765	739	779	673		779	763	757	26
28	710	694	720	629	724	707	733	648		735	735	717	28
30	675	670	680	607	683	674	689	624		689	689	676	30
32	637	635	641	586	642	641	644	601		642	643	637	32
34	599	599	603	564	603	604	599	579		595	597	597	34
36	562	563	567	541	564	565	558	556		559	560	558	36
38	530	531	531	517	525	526	526	527		526	526	519	38
40	499	500	494	494	492	493	495	497		492	493	492	40
44	438	439	444	445	440	440	436	438		435	437	436	44
48	381	383	394	396	390	392	394	395		391	391	390	48
52	325	328	347	350	352	355	352	354		350	351	353	52
56	272	275	300	305	312	313	319	323		319	319	317	56
60	217	214	256	259	265	266	287	292		289	286	291	60
64			212	214	218	218	249	252		252	253	265	64
68			155				210	212		215	215	236	68
72							167			171		204	72
76												170	76

VKTAB 190090 / 190092

m	66 m				72 m				78 m				m
	12 m		18 m		12 m		18 m		12 m		18 m		
	12°	20°	12°	20°	12°	20°	12°	20°	12°	20°	12°	20°	
18	791				688								18
20	791	791	720		688	688	643			636	636		20
22	791	791	713	679	688	688	639	609		636	636	571	22
24	791	788	708	676	688	688	633	607		636	631	566	24
26	756	755	701	673	688	688	628	603		636	625	562	26
28	717	716	676	666	683	675	619	600		629	618	557	28
30	677	677	652	642	659	653	608	591		619	609	551	30
32	636	636	625	619	625	625	597	581		609	601	545	32
34	594	595	589	590	588	589	578	571		576	577	539	34
36	553	555	554	556	551	553	547	548		544	545	523	36
38	520	520	519	522	514	517	516	518		512	513	498	38
40	490	491	483	489	484	485	484	488		479	481	473	40
44	431	432	434	436	432	433	430	431		428	429	423	44
48	387	389	386	388	381	383	386	388		382	383	382	48
52	349	349	349	350	346	347	343	345		340	342	343	52
56	314	315	316	317	312	312	314	315		310	311	308	56
60	288	287	285	287	283	284	285	286		280	280	282	60
64	261	260	263	264	260	260	258	260		254	256	256	64
68	233	236	240	240	236	236	238	239		234	234	233	68
72	206	209	217	218	214	217	218	218		214	213	215	72
76	172	171	193	197	193	198	199	200		195	196	197	76
80			167	168	167	167	180	183		179	179	180	80
84			132		132		161	161		161	159	165	84
88							134	133		132	131	150	88
92												129	92
96												100	96

VKTAB 190090 / 190092

Traglasten am SDWVB2-Auslegersystem

Lifting capacities on SDWVB2 boom/jib combination

Forces de levage en configuration SDWVB2 · Portate con sistema braccio SDWVB2

Tablas de carga con sistema de pluma SDWVB2 · Грузоподъемность на стреловой системе SDWVB2

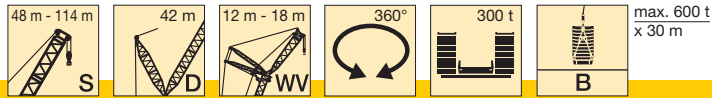

Vorläufig
Préliminaire · Provisorio
Provisional · Временно
Preliminary

m	84 m				90 m				96 m				m	
	12 m		18 m		12 m		18 m		12 m		18 m			
	12°	20°	12°	20°	12°	20°	12°	20°	12°	20°	12°	20°		
20	582				524					468	457			20
22	582	567	511		520	507	456			464	455	409		22
24	577	562	508	487	514	504	453	436		464	455	409		24
26	571	558	502	485	509	498	448	434	460	451	406			26
28	560	553	498	481	504	494	444	430	456	448	402	393		28
30	557	546	491	477	496	488	440	426	452	444	399	391		30
32	550	540	486	471	490	482	434	423	448	441	396	388		32
34	540	534	480	467	483	477	429	418	443	437	392	385		34
36	516	513	474	462	474	470	424	414	439	433	388	382		36
38	492	490	460	456	458	455	419	409	429	427	385	379		38
40	468	468	443	441	442	441	408	403	417	415	381	376		40
44	420	422	410	409	410	411	387	384	392	392	364	373		44
48	380	381	376	378	375	377	366	365	367	369	348	361		48
52	339	339	341	343	339	340	338	339	334	335	330	346		52
56	305	307	306	308	302	302	306	308	301	301	301	332		56
60	278	279	277	279	275	276	274	276	268	270	273	303		60
64	252	251	254	255	251	252	251	252	247	248	244	274		64
68	230	231	231	231	227	227	230	231	225	225	225	246		68
72	211	212	210	212	208	209	209	209	204	203	206	227		72
76	193	192	195	195	192	192	191	192	187	188	188	207		76
80	177	178	179	179	176	175	177	178	173	173	172	188		80
84	163	164	163	165	161	162	163	163	158	158	159	173		84
88	150	148	151	152	149	149	148	149	144	144	146	160		88
92	128	126	138	140	138	136	137	138	133	132	133	146		92
96	98		122	123	122	121	125	127	122	120	123	134		96
100			100	100	98		114	115	111	110	114	124		100
104							97	97	97	95	105	114		104
108							73		72		92	104		108
112											73	93		112

VKTAB 190090 / 190092

m	102 m				108 m				114 m				m	
	12 m		18 m		12 m		18 m		12 m		18 m			
	12°	20°	12°	20°	12°	20°	12°	20°	12°	20°	12°	20°		
22	417				375					331				22
24	414	406	365		372	366	330			329	323	291		24
26	409	403	362	351	370	364	328			329	323	291		26
28	406	398	359	349	367	361	327	317		325	321	289	282	28
30	402	395	356	346	365	360	324	316		323	319	286	280	30
32	394	391	353	343	363	358	322	314		321	317	284	277	32
34	392	387	348	341	356	353	320	312		317	315	282	276	34
36	388	384	344	337	356	352	317	311		315	311	280	274	36
38	384	380	340	334	353	349	315	308		312	309	277	272	38
40	377	374	337	331	350	347	313	307		310	307	275	270	40
44	363	363	321	320	340	338	306	303		298	297	270	266	44
48	350	351	320	317	329	329	299	297		296	295	260	259	48
52	329	331	312	309	318	321	292	291		290	290	259	256	52
56	299	300	295	295	294	295	285	286		280	279	254	251	56
60	269	270	270	270	266	267	264	266		258	257	244	243	60
64	242	244	244	245	239	239	241	243		236	236	227	228	64
68	223	224	221	223	217	219	219	221		214	215	211	212	68
72	204	204	204	205	199	200	200	202		197	198	195	197	72
76	184	184	187	188	182	182	184	186		181	181	180	182	76
80	170	171	170	170	165	165	169	169		164	164	165	167	80
84	157	157	156	157	151	152	153	153		148	149	151	152	84
88	144	143	144	145	140	140	140	142		137	138	136	137	88
92	130	131	132	132	128	127	129	130		126	126	125	126	92
96	121	121	121	121	116	116	119	119		115	114	115	116	96
100	111	111	111	112	107	107	108	108		104	104	106	106	100
104	102	101	102	102	98	97	99	99		95	95	96	95	104
108	89	89	94	93	89	89	91	91		87	87	87	87	108
112	71		84	86	79	81	83	82		79	78	80	80	112
116			71	70	67	66	75	75		71	71	72	72	116
120			49.5		46		64	64		61	60	65	65	120
124							47.5			44.5		56	57	124
128												45	44	128
132												27.6		132

VKTAB 190090 / 190092

Anmerkungen zu den Traglasttabellen

1. Für die Kranberechnungen gelten die DIN-Vorschriften lt. Gesetz gemäß Bundesarbeitsblatt von 2/85: Die Traglasten DIN/ISO entsprechen den geforderten Standsicherheiten nach DIN 15019, Teil 2 und ISO 4305 (Prüflast = 1,25 x Hublast + 0,1 x Auslegereigengewicht auf die Auslegerspitze reduziert). Für die Stahtragwerke gilt DIN 15018, Teil 3. Die bauliche Ausbildung des Krans entspricht DIN 15018, Teil 2 sowie der F.E.M.
2. Die Traglasten sind in Tonnen angegeben.
3. Das Gewicht des Lasthakens bzw. der Hakenflasche sowie der Anschlagmittel ist von den Traglasten abzuziehen.
4. Die Ausladungen sind von Mitte Drehkranz gemessen.
5. Kranbetrieb – wenn nicht speziell dokumentiert – zulässig bis: Staudruck 50 N/m², Windgeschwindigkeit 9 m/s.
Weitere Angaben über Windgeschwindigkeiten sind der Bedienungsanleitung zu entnehmen.
6. Die Aufstandsfläche muß eben und tragfähig sein.
7. Traglaständerungen vorbehalten.
8. Der Kran kann mit den in den Traglasttabellen angegebenen Lasten verfahren. Die Betriebsbedingungen sind der Bedienungsanleitung zu entnehmen.
9. Traglasten über 1350 t nur mit Zusatzeinrichtung.

Remarks referring to load charts

1. When calculating crane stresses and loads, German Industrial Standards (DIN) are applicable, in conformance with new German legislation (published 2/85). The lifting capacities (stability margin) DIN/ISO correspond to DIN 15019, part 2, and ISO 4305 (Tested load = 1.25 x lifting capacity + 0.1 x boom dead weight, reduced to the boom point). The crane's structural steel work is in accordance with DIN 15018, part 3. Design and construction of the crane comply with DIN 15018, part 2 and with F.E.M. regulations.
2. Lifting capacities are given in metric tons.
3. The weight of the load hook and hook blocks as well as of the lifting tackle must be deducted from the lifting capacities.
4. The working radii are measured from the slewing centreline.
5. Unless particularly specified, crane operation is permissible up to a dynamic pressure of 50 N/m², wind speed of 9 m/s.
For further details in respect to wind speeds refer to the operating instructions.
6. The subsoil must be even and of good bearing capacity.
7. Subject to modification of lifting capacities.
8. The crane can be displaced with suspended loads as stated in the load charts. Operating conditions must conform to the rules in the operating instructions.
9. Lifting capacities above 1350 t only with special equipment.

Remarques relatives aux tableaux des charges

1. La grue est calculée selon normes DIN conformément au décret fédéral 2/85. Les charges DIN/ISO respectent les sécurités au basculement requises par les normes DIN 15019, partie 2 et ISO 4305. La structure de la grue est conçue selon la norme DIN 15018, partie 3. La conception générale est réalisée selon la norme DIN 15018, partie 2, ainsi que selon les recommandations de la F.E.M.
2. Les charges sont indiquées en tonnes.
3. Les poids du crochet ou du moufle ainsi que des élingues sont à déduire des charges indiquées.
4. Les portées sont prises à partir de l'axe de rotation de la partie tournante.
5. Sinon spécifié autrement, le service de grue est admissible jusqu'à une pression dynamique de 50 N/m², vitesse de vent de 9 m/s.
D'autres indications concernant les vitesses de vent sont stipulées dans les instructions de service.
6. Le sol doit être plat et résistant.
7. Charges données sous réserve de modification.
8. La grue peut être déplacée avec les charges indiquées dans les tableaux des charges. Les conditions de service sont stipulées dans les instructions de service.
9. Forces de levage plus de 1350 t seulement avec équipement supplémentaire.

Osservazioni su tabella di portata

1. I calcoli gru vengono fatti secondo le normative DIN. Le portate DIN/ISO soddisfano le norme per la sicurezza DIN 15019, parte 2 e ISO 4305.
Per le strutture in acciaio è valida la norma DIN 15018, parte 3. La costruzione della gru soddisfa la normativa DIN 15018, parte 2 così come F.E.M.
2. Le portate sono indicate in tonnellate.
3. Il peso del gancio del bozzello nonché di ulteriori accessori vanno sottratti dalle portate.
4. Gli sbracci sono misurati dal centro della ralla.
5. Funzionamento della gru - se non specificatamente documentato – è ammissibile fino: portanza 50 N/m², velocità del vento 9 m/s. Ulteriori indicazioni relative alla velocità del vento sono indicate nel manuale uso della gru.
6. La superficie adibita al montaggio deve essere piana e in grado di sopportare il carico.
7. Con riserva di modifiche di portata.
8. La gru si può movimentare con carichi indicati nelle tabelle. Ulteriori condizioni di utilizzo vengono riportate nel manuale d'uso della gru.
9. Portate superiori a 1350 t solo con equipaggiamento addizionale

Observaciones relativas a las tablas de carga

1. Para los cálculos de grúa se aplican las normas DIN conforme a la ley según la hoja de servicios de la RFA del 2/85: Las capacidades de carga DIN/ISO corresponden a la estabilidad de seguridad requerida según DIN 15019, parte 2, e ISO 4305 (carga de prueba = 1,25 x carga de elevación + 0,1 x peso propio de la pluma reducido a la cabeza de pluma). Para las estructuras metálicas portantes se aplica la norma DIN 15018, parte 3. La configuración estructural de la grúa corresponde a DIN 15018, parte 2, y al F.E.M.
2. Las capacidades de carga se indican en toneladas.
3. El peso del gancho de carga o de la pasteca, así como de los accesorios de eslingado, se ha de restar de las capacidades de carga.
4. Los radios de trabajo se han medido desde el centro de la corona de giro.
5. Servicio de grúa - si no se documenta especialmente - admisible hasta: presión de remanso 50 N/m², velocidad del viento 9 m/s.
Para más datos sobre la velocidad del viento, consultar las instrucciones de servicio.
6. La superficie de apoyo ha de ser llana y firme.
7. Las capacidades de carga están sujetas a modificaciones.
8. La grúa puede desplazarse con las cargas indicadas en las tablas de carga. Las condiciones de servicio se indican en las instrucciones de servicio.
9. Cargas por encima de las 1350 t sólo con dispositivo adicional.

Примечания к таблицам грузоподъемности

1. Для расчетов крану действуют предписания DIN согласно закона в соответствии с федеральной рабочей расчетной таблицей от 2/85: грузоподъемности DIN/ISO соответствуют требуемым показателям устойчивости крана по DIN 15019, часть 2 и ISO 4305 (контрольный груз = 1,25 x поднимаемый груз + 0,1 x собственный вес стрелы, приведенный к концу стрелы). Для стальных несущих конструкций действует DIN 15018, часть 3. Конструктивное исполнение крана соответствует DIN 15018, часть 2, а также F.E.M.
2. Грузоподъемности указаны в тоннах.
3. Вес грузового крюка или крюковой подвески, а также строповочных средств должен быть вычтен из значения грузоподъемности.
4. Вылет измеряется от середины опорно-поворотного круга.
5. Работа крана разрешается (если в документах специально не указано иное) до: скоростного напора ветра 50 н/м², скорости ветра до 9 м/с.
Прочие данные скорости ветра в соответствии с руководством по эксплуатации.
6. Место установки должно быть ровным и прочным.
7. Возможны изменения значений грузоподъемности.
8. Кран может перемещаться с грузами, приведенными в таблицах грузоподъемности. Условия такого режима в соответствии с руководством по эксплуатации.
9. Грузы более 1350 т только с дополнительным устройством.